



PORSCHE



Autumn | Winter 2021

Porsche Driver's Selection



Essential Collection



Home and Office



Porsche Originals

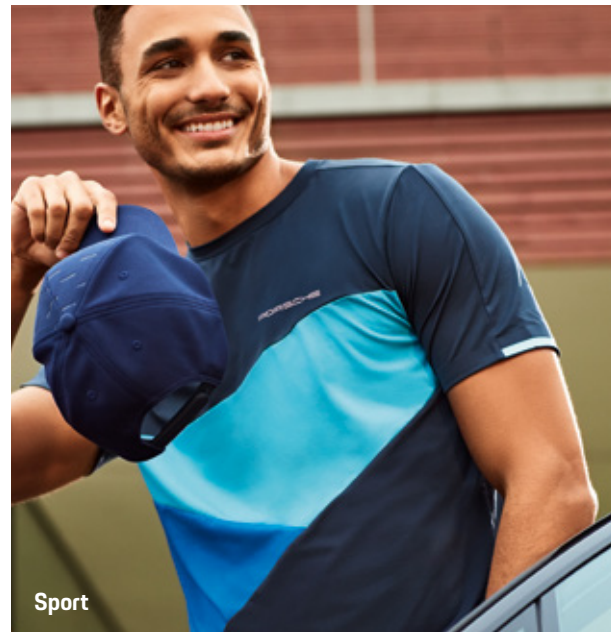

Sport

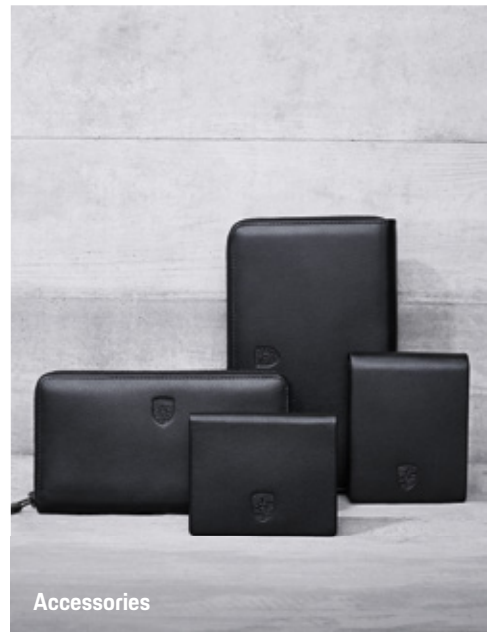

Accessories



Glasses

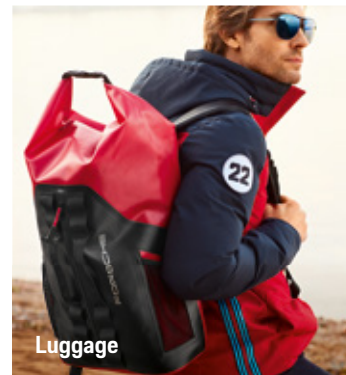

Luggage

Porsche Driver's Selection

Porsche Driver's Selection is Fascination Porsche that extends beyond the open road. Because the wide range of products creates numerous opportunities to elevate your own sports car passion to Porsche Lifestyle.

For example, with the diverse fashion collections that combine sporty cuts and ingenious designs with the flair of Porsche legends. With charming accessories for home and office, with high-tech sports equipment for reaching your personal best, or with model vehicles that are identical to the cars they are based on, right down to the smallest detail.

Whether it's a limited-edition collector's item or an extraordinary designer piece – every Porsche Driver's Selection product not only meets the highest standards in terms of technology, materials and workmanship, but is also infused with palpable sports car passion.

Size guidance: the male model is approx. 1.85m tall and wears size M.
Size guidance: the female model is approx. 1.75m tall and wears size S.



Watches



Children



Model cars



Contents

Porsche Driver's Selection

01. Collections

New. 968 L'ART x Porsche	6
911 GT3 Collection	10
Sports Collection	16
MARTINI RACING® Collection	28
917 'Pink Pig' Collection	52
Motorsport Replica Collection	58
Motorsport Fanwear Collection	66
Heritage Collection	80
917 Salzburg Collection	88
Turbo Collection	96
Transaxle Collection	102
Essential Collection	108
Taycan Collection	120
Urban Explorer Collection	132

02. Products

Glasses	138
Watches	146
Luggage	152
Porsche Pet's Collection	168
Porsche Originals	172
Home and Office	186
Electronic devices	204
Calendars and books	208
Leather accessories	214
Accessories	222
Racewear	236
Children	244
Model cars	260

03. Service

Standard clothing sizes	316
Luggage combinations	320





968 L'ART Collection by L'Art De L'Automobile x Porsche

There are legends that live forever. Our transaxle models for example, are real classics with cult status. With the engine at the front, transmission in the rear and heaps of personality in between. Designer and Porsche enthusiast Arthur Kar has given a modern and visionary interpretation to one of the legendary sports cars from the transaxle era: To accompany the 968 L'ART Collection by L'Art De L'Automobile x Porsche, we also present a matching street wear collection with multicolored L'ART prints and casual style.

New



Unisex T-shirt – Transaxle Collection

Short-sleeved T-shirt with a crew neck. Multicolored L'ART print on the breast. Porsche logo on neck. 100% cotton. In white.

WAP130XXXONTRA

New



Unisex T-shirt – Transaxle Collection

Short-sleeved T-shirt with a crew neck. Multicolored KAR print Porsche Crest on the back. 100% cotton. In black.

WAP131XXXONTRA

New



Men's jacket – Transaxle Collection

Lightweight jacket with stand-up collar and diverse decorative stitching. Porsche logo on the collar and back. Porsche Crest badge on the upper arm. Two side pockets and one inside pocket. Outer material: 100% cotton. Lining: 100% polyester. In black/green.

WAP132XXXONTRA

New



Men's sweatshirt – Transaxle Collection

Men's sweatshirt with multicolored L'ART print on the back. 98% cotton, 2% polyester. In black.

WAP133XXXONTRA

New



New



Cap – Transaxle Collection

Cap with printed logos and Crest badge. Printed Velcro fastening at the back. 100% cotton. In black.

WAP134001ONTRA



911 GT3 Collection

Time is precious. That applies to every single second. And especially those spent behind the wheel of the new 911 GT3. Because it delivers maximum performance lap after lap. Something that you can also now experience away from the race track – in the form of the new 911 GT3 Collection. It shares the same design and uncompromising quality as the car itself.

Highly functional, with countless smart details and a unique color – the new Shark Blue – it really pushes the boundaries. And proves that peak performance is possible without even starting the engine.



Men's T-shirt – 911 GT3

Short-sleeved T-shirt with a crew neck and GT3 embossing. In 100% cotton jersey. In blue.

WAP8100XS-3XL0MGT3



2-in-1 men's gilet with jacket – 911 GT3

2-in-1 gilet with jacket: jacket can be stowed in the hem of the gilet. The invisible compartment for this is fitted with a zip. Reversible padded gilet with two side pockets and stand-up collar. Grey side quilted with color, blue side not quilted. Porsche logo on the chest and collar. Lightweight wind jacket with hood and two side pockets in blue, made of 100% polyamide. In grey/blue.

WAP8110XS-3XL0MGT3



Flat brim cap unisex – 911 GT3

Flat brim cap with large embroidered GT3 logo and snap-back fastener with Porsche embossing. With black strap on the back. Outer material: 60% cotton/40% polyester. Lining: 100% cotton.

WAP8100010MGT3



Thermos cup – 911 GT3

High-quality thermo-insulated cup made from double-walled stainless steel. With the Porsche Crest on the body and embossed 'PORSCHE' logo on the lid. Keeps hot drinks warm and cold drinks cool. In Shark Blue. Capacity: approx. 450ml.

WAP0500660MD5C



Lanyard – 911 GT3

Short lanyard – inspired by the 911 GT3 door loop. With Porsche logo, carabiner, 1 × standard key ring, 1 × small key ring. In blue. Strap: 100% polyester. Carabiner: 100% zinc alloy. Badge: 100% silicone rubber.

WAP0508010MGT3

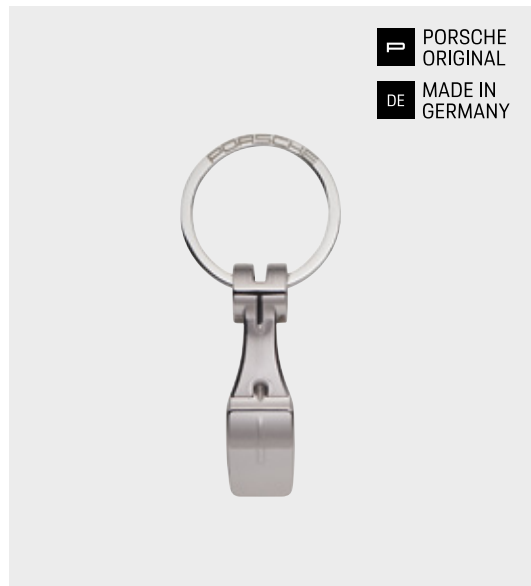

P PORSCHE
ORIGINAL
DE MADE IN
GERMANY

Cam follower key ring – 911 GT3

Key ring made from an original GT3 cam follower.
In polished silver color with Porsche engraving
on the key ring.

WAP0500100MGT3



911 GT3

In Shark Blue. Interior in black.
Made of metal. Scale 1:43.

WAP0201490M005



911 GT3

In Jet Black Metallic. Interior in black.
Made of metal. Scale 1:43.

WAP0201520M007

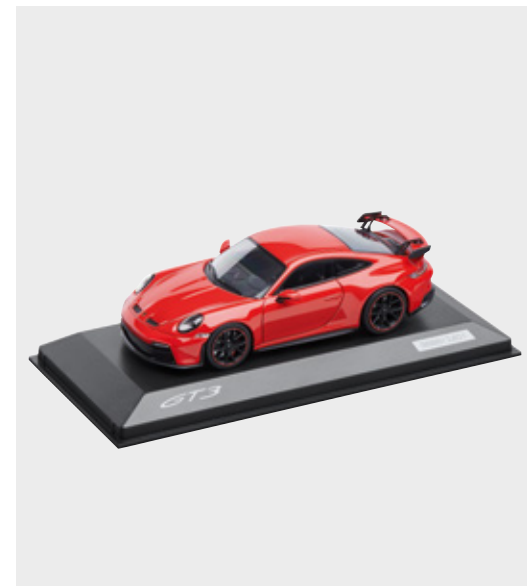

911 GT3

In Guards Red. Interior in black.
Made of metal. Scale 1:43.

WAP0201510M006

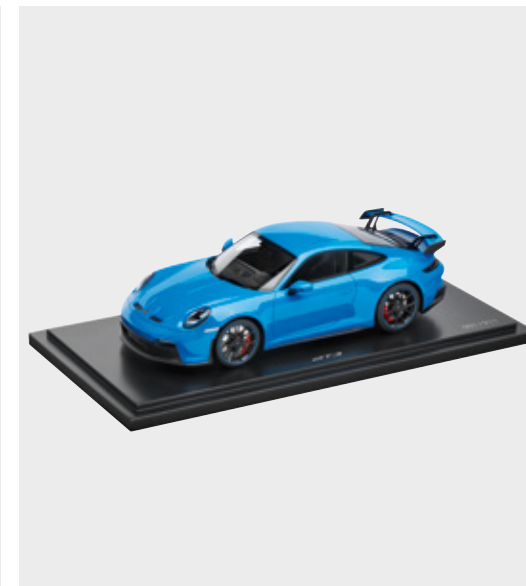

911 GT3

In Shark Blue. Interior in black.
Made of resin. Scale 1:18.

WAP0211490M003

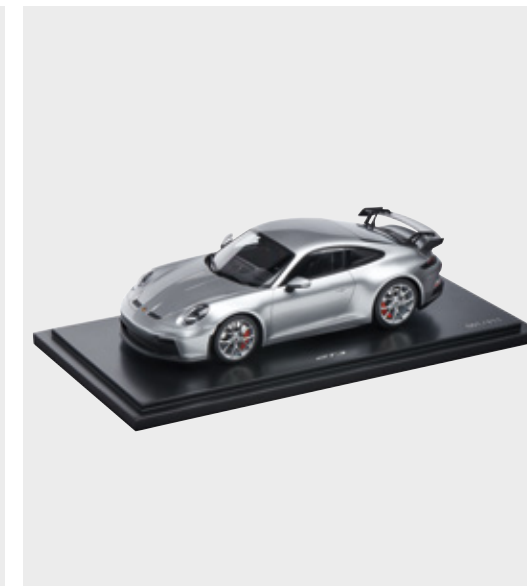

911 GT3

In GT Silver Metallic. Interior in black.
Made of resin. Scale 1:18.

WAP0211510M004



Sports Collection

Seconds not only count on the race track or the open road – but also when playing your own favourite sport. Ably assisted by the new Sports Collection as your perfect training partner – whether on the golf course, running track, in the gym or at home.

With a sporty design, modern materials, practical features and intelligent, performance-oriented cuts. For personal bests that not only make you feel good, but also look good.

—
Panamera Turbo S Sport Turismo: fuel consumption in l/100km: urban 15.0–14.9 · extra urban 8.8–8.7 · combined 11.1–11.0 [NEDC]; combined 13.3–13.0 [WLTP]; CO₂ emissions in g/km combined: 253–251 [NEDC]; 302–295 [WLTP]



Men's polo shirt – Sport

Polo shirt made of functional piqué with raglan sleeves and three buttons. Stretchy, quick-drying and breathable. Porsche logo on the sleeve and chest. 100% polyester. In light grey with light blue details.

WAP5340XS-3XL0MOSP



Women's polo shirt – Sport

Short-sleeved polo shirt made of functional jersey with baseball collar and zip. Stretchy, quick-drying and breathable. Decorative ribbed edging in coral/pink and subtle tonal prints on the chest, shoulder yoke and left sleeve. 100% polyester. In coral with details in pink.

WAP5380XS-XXL0MOSP



Men's T-shirt – Sport

Men's sporty short-sleeved T-shirt with crew neck made of functional jersey. Stretchy, quick-drying and breathable. 100% polyester. In various shades of blue.

WAP5350XS-3XL0MOSP

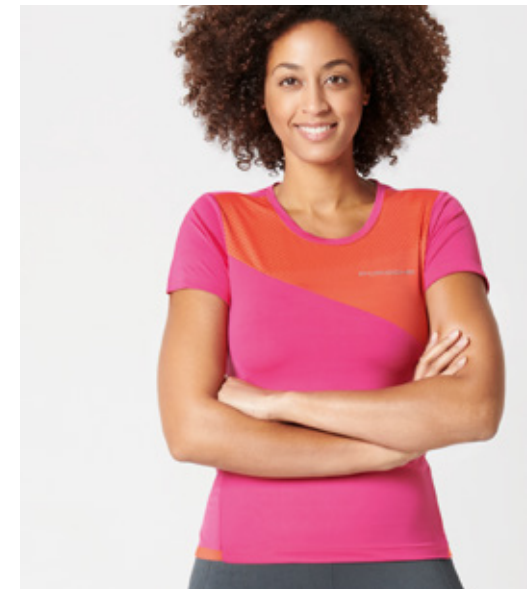

Women's T-shirt – Sport

Short-sleeved T-shirt made of functional jersey with feminine crew neck and subtle tonal print on the chest. Stretchy, quick-drying and breathable. 100% polyester. In coral with details in pink.

WAP5390XS-XXL0MOSP



Men's long-sleeved top – Sport

Sporty long-sleeved top with stand-up collar, zip and chest pocket. With embossing on the chest and shoulder yoke. Made from functional jersey with fleece inner: insulating, stretchy, quick-drying and breathable. 88% polyester, 12% elastane. In dark blue with light blue details.

WAP5330XS-3XL0MOSP

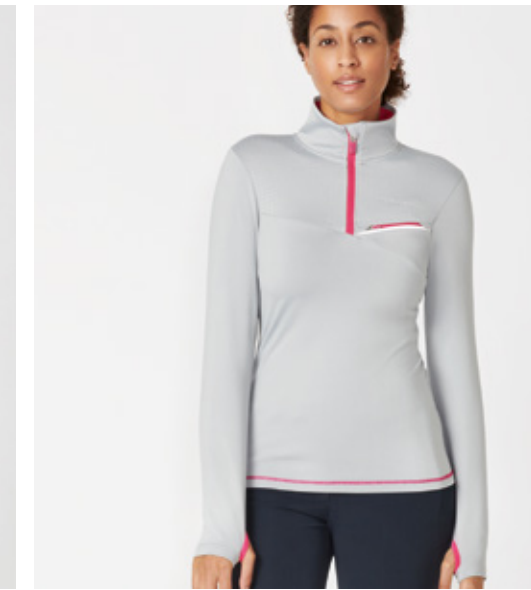

Women's long-sleeved top – Sport

Sporty long-sleeved top with stand-up collar, zip and chest pocket. With embossing on the chest and shoulder yoke. Made from functional jersey with fleece inner: insulating, stretchy, quick-drying and breathable. 88% polyester, 12% elastane. In grey with details in pink.

WAP5370XS-XXL0MOSP



Men's gilet – Sport

Lightweight, comfortable softshell gilet. Insulating as well as wind and water-repellent. Shoulders and collar made of softshell material. Lightly padded upper front and back. Two side pockets and one chest pocket. Back panel at waist decorated with elasticated band and Porsche logo. Outer fabric [softshell and padded parts]: 100% polyester. Filling: 100% polyester. Lining: 100% polyester. In dark blue with light blue details.

WAP5320XS-3XL0MOSP

Women's gilet – Sport

Lightweight, comfortable softshell gilet. Insulating as well as wind and water-repellent. Shoulders and collar made of softshell material. Lightly padded upper front and back. Two side pockets and one chest pocket. Back panel at waist decorated with elasticated band and Porsche logo. Outer fabric [softshell and padded parts]: 100% polyester. Filling: 100% polyester. Lining: 100% polyester. In coral with details in pink.

WAP5360XS-XXL0MOSP



Men's jacket – Sport

Lightweight, comfortable softshell jacket. Insulating as well as wind and water-repellent. Body, sleeves, shoulders and collar made of softshell material. Lightly padded upper front and back. Two side pockets, one chest pocket and one pocket at the bottom of the right sleeves. Back panel at waist decorated with elasticated band and Porsche logo. Outer fabric [softshell and padded parts]: 100% polyester. Filling: 100% polyester. Lining: 100% polyester. In dark blue with light blue details.

WAP5310XS-3XL0MOSP



Baseball cap unisex – Sport

Five-panel cap made of elastic material. Breathable, quick-drying and comfortable to wear. Linear embossing and Porsche logo on the front. Sandwich peak in light blue. Snap-back fastener also features Porsche embossing. One-size-fits-all: 57–59cm. Outer fabric: 100% polyester. Lining: 75% cotton, 25% polyester. In dark blue with details in light blue.

WAP5400010MOSP



Unisex visor – Sport

Visor made of elastic material. Breathable, quick-drying and comfortable to wear. Linear embossing and Porsche logo on the front. Sandwich peak in light blue. Snap-back fastener with Porsche embossing and contrasting stitching in light blue. One-size-fits-all: 57–59cm. Outer fabric: 100% polyester. Lining: 75% cotton, 25% polyester. In white with details in light blue.

WAP5410020MOSP



Women's T-shirt – Sport

Functional piqué T-shirt. The elastic material is breathable, quick-drying and extremely comfortable during sport. With 'PORSCHE' logo on the back. Shoulders printed with a honeycomb pattern. 95% polyester, 5% elastane. In dark blue with details in Acid Green.

WAP5480XS-XXLOJ



Golf towel – Sport

Golf towel with soft woven velour on the front and terry cloth on the rear. With practical snap hook to easily attach it to your golf bag. Dimensions: 50 × 50cm. 100% cotton. In black with light blue accents.

WAP5420030M0SP



Golf towel – Sport

Golf towel with soft woven velour on the front and terry cloth on the rear. With practical snap hook to easily attach it to your golf bag. Dimensions: 50 × 50cm. 100% cotton. In dark blue with details in Acid Green.

WAP5400020J



Golf Balls Tour Soft 3 Pieces

Hightech-Golfball Titleist Pro NXT® Tour.

WAP0600430K





Golf stand bag

Stand bag made of coated, waterproof nylon with six storage pockets and space for a large drinks bottle. Seamlessly integrated stand system and balanced, adjustable carrying system. Silver-colored 'PORSCHE' print with grid pattern on the side.

WAP0350500MSTB



Golf cart bag

Cart bag made of coated, waterproof nylon with nine patch pockets and padded carrying handle. Inner lined pocket for valuables as well as umbrella, glove and towel holder. With silver-colored 'PORSCHE' print and grid print on the side.

WAP0350510MCTB



Travel bag

Travel bag made of coated tarpaulin with heavily padded side walls and strap featuring tear-proof bonding. Internal storage pockets and ball-bearing skater wheels. Ideal for golf bags up to 11 inches. Silver-colored 'PORSCHE' print.

WAP0350520MTRB

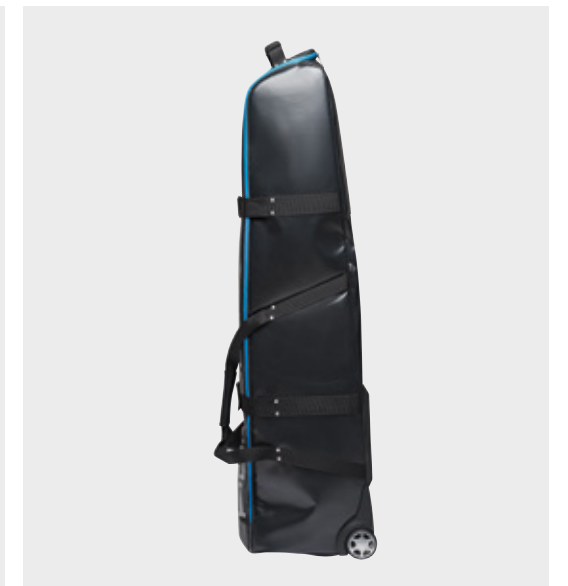

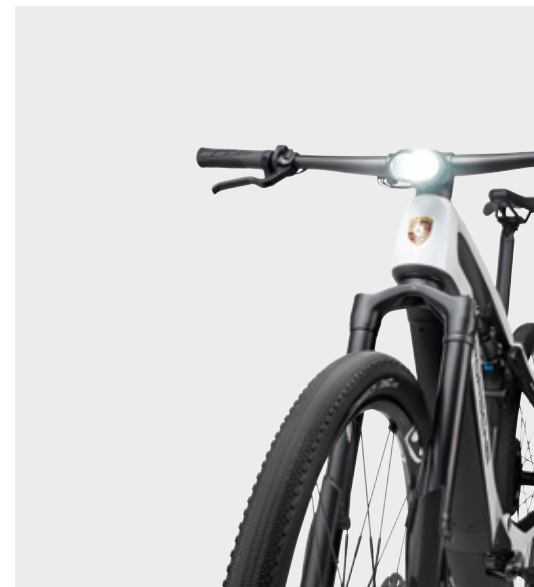

Porsche eBike Sport

High-quality Porsche eBike in cooperation with ROTWILD. Full-suspension carbon frame with shock absorbers from FOX and internal cables, designed by Studio F. A. Porsche. Latest generation SHIMANO drive unit consisting of engine, battery and electronic gears. A tidy cockpit thanks to MAGURA Cockpit integration [MCi]. Integrated brake in the handlebar with eBike-optimised brake discs and upside-down suspension fork from MAGURA. Front and rear SUPERNOVA lights integrated into the handlebar stem and seat post. Wheels from CRANKBROTHERS. Color: white/black. Frames available in three sizes [S, M, L].

Frame size S: WAP061EBT0M00S

Frame size M: WAP061EBT0M00M

Frame size L: WAP061EBT0M00L

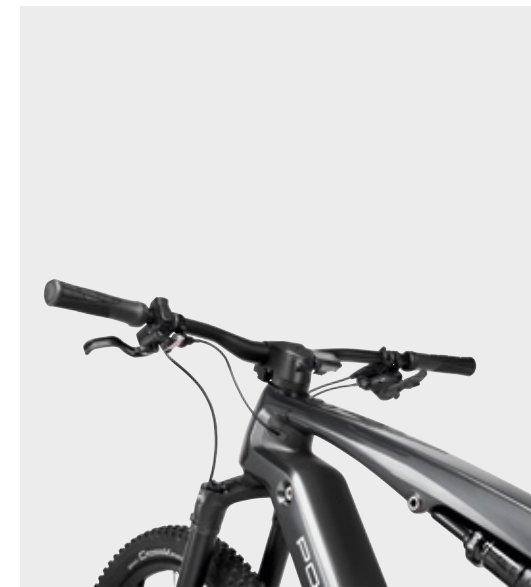

Porsche eBike Cross

High-quality Porsche eBike in cooperation with ROTWILD. Full-suspension carbon frame with shock absorbers from FOX and internal cables, designed by Studio F. A. Porsche. Latest generation SHIMANO drive unit consisting of engine, battery and gears. Hydraulic disc brakes with eBike-optimised brake discs and upside-down suspension fork from MAGURA. Adjustable seat post via handlebar remote control and wheels by CRANKBROTHERS. Color: dark grey/black. Frames available in three sizes [S, M, L].

Frame size S: WAP061EBS0M00S

Frame size M: WAP061EBS0M00M

Frame size L: WAP061EBS0M00L





MARTINI RACING® Collection

Le Mans 1971 is remembered for the phenomenal success of the Porsche 917 KH, whose colored paintwork – the MARTINI RACING® look – made history. The new MARTINI RACING® Collection is an updated interpretation of this iconic era of motorsport, in classic colors, with a sporty style and subtle racing accents, as an unmistakable tribute to Le Mans 1971.



Men's polo shirt – MARTINI RACING®

Men's short-sleeved polo shirt made of 100% cotton with two buttons and badges, inspired by the Porsche 917 KH from 1971. With mesh band on the shoulders and sleeves in the classic MARTINI RACING® stripe design. Tonal Porsche print on the back. In dark blue.

WAP5530XS-3XL0M0MR



Women's polo shirt – MARTINI RACING®

Women's short-sleeved polo shirt with three buttons and badges, inspired by the Porsche 917 KH from 1971. Tonal Porsche print on the shoulder yoke. Pleat below the shoulder yoke. Knitted fabric made of 96% cotton and 4% elastane. In light blue.

WAP5570XS-XXL0M0MR



Unisex collector's T-shirt no. 20 – Limited Edition – MARTINI RACING®

Short-sleeved T-shirt. Print design inspired by the Porsche 917 KH from 1971. Packaged in an exclusive metal box printed with the same motif. Includes a postcard explaining the print. Very soft quality T-shirt. 100% cotton. In grey melange.

WAP5580XS-3XL0M0MR



Men's board shorts – MARTINI RACING®

Swimming trunks made of quick-drying fabric with elastic waistband and drawstring. Two side pockets – one with a zip. The integrated mesh slip ensures comfort. Side and back with mesh band in the classic MARTINI RACING® stripe design. Silicone badges on the front and back, Porsche logo print on the back. Outer fabric: 100% polyester. Lining: 100% polyester. In olive green.

WAP5540XS-3XL0M0MR



Men's training jacket – MARTINI RACING®

Training jacket with stand-up collar and badges, inspired by the Porsche 917 KH from 1971. With two side pockets and mesh band on the sleeves in the classic MARTINI RACING® stripe design. Tonal Porsche print on the back. Made of 91.5% polyester and 8.5% elastane. In grey melange/dark blue.

WAP5510XS-3XL0M0MR



Men's piqué jacket – MARTINI RACING®

Lightweight sweat jacket with stand-up collar and badges, inspired by the Porsche 917 KH from 1971. With mesh band on the sleeves and shoulders in the classic MARTINI RACING® stripe design. Zips on the side pockets. Tonal Porsche print on the back. Knitted fabric made of 74% cotton and 26% polyester. In olive green.

WAP5520XS-3XL0M0MR



Women's piqué jacket – MARTINI RACING®

Lightweight sweat jacket with stand-up collar and badges, inspired by the Porsche 917 KH from 1971. With mesh band on the sleeves and shoulders in the classic MARTINI RACING® stripe design. Both side pockets with zips. Tonal Porsche print on the back. Made of 74% cotton and 26% polyester. In olive green.

WAP5560XS-3XL0M0MR



Men's quilted jacket – MARTINI RACING®

Padded, warm, wind and water-repellent quilted jacket with stand-up collar and hood. With mesh band on the side panels and underarms in the classic MARTINI RACING® stripe design and embroidered Porsche logo in white on the back. The badges are inspired by the Porsche 917 KH from 1971. Two side pockets, inner pocket with zip. Front zip reversed in red. Underflap with tonal Porsche logo print. Red lining with story label. Outer fabric [mesh]: 100% polyester. Lining: 100% polyester. Filling: 100% polyester. In red/dark blue.

WAP5500XS-3XL0M0MR

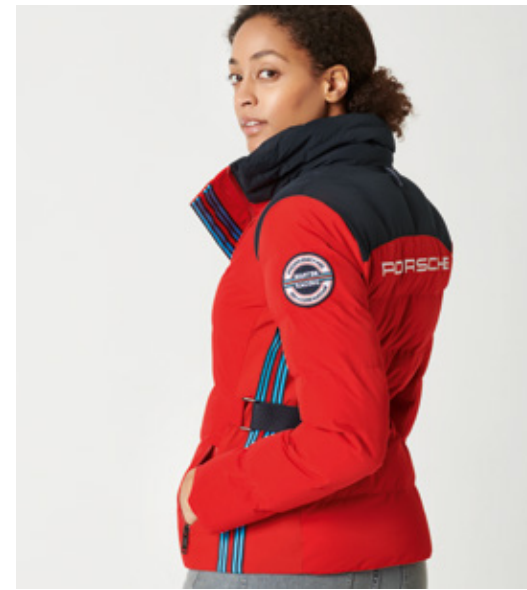

Women's quilted jacket – MARTINI RACING®

Padded, warm, wind and water-repellent quilted jacket with stand-up collar. With mesh band on the side panels and underarms in the classic MARTINI RACING® stripe design and embroidered Porsche logo in white on the back. The badges are inspired by the Porsche 917 KH from 1971. Two side pockets, inner pocket with zip. Front zip reversed in red. Wide underflap trimmed with mesh MARTINI RACING® band and tonal Porsche logo print. Red lining with story label. Outer fabric [mesh]: 100% polyester. Lining: 100% polyester. Filling: 100% polyester. In red/dark blue.

WAP5550XS-3XL0M0MR





Men's polo shirt – MARTINI RACING®

Short-sleeved polo shirt with two buttons. Side seams and collars with ribbons in the typical MARTINI RACING® colors. 'MARTINI RACING® PORSCHÉ' badge on the chest and badge with number 3 on the upper arm. 'PORSCHÉ' logo printed tonal on the back. Collar patch inspired by Porsche 917 'Hippie'. 100% cotton. In blue.

WAP92200S-3XL0LMRH



Women's polo shirt – MARTINI RACING®

Short-sleeved polo shirt with three buttons. Side seams and collars with ribbons in the typical MARTINI RACING® colors. 'MARTINI RACING® PORSCHÉ' badge on the chest and badge with number 3 on the upper arm. 'PORSCHÉ' logo printed tonal on the back. Collar patch inspired by Porsche 917 'Hippie'. 100% cotton. In blue.

WAP9210XS-XXL0LMRH



LE LIMITED EDITION



LE LIMITED EDITION

Collector's T-shirt edition no. 18 Unisex – Limited Edition – MARTINI RACING®

Porsche 917 'Hippie' Collector's shirt. Packaged in an exclusive metal box printed with the same motif. Includes a postcard explaining the printed motif. Very soft quality T-shirt. 100% cotton. In dark blue

WAP6710XS-3XL0LMRH



Men's T-shirt – MARTINI RACING®

Short-sleeved T-shirt with a crew neck in dark blue and green. Decorative band on shoulders and neckline in typical MARTINI RACING® colors. 'MARTINI RACING® PORSCHE' badge on the chest and number 3 badge on the upper arm. 'PORSCHE' logo printed tonal on the back. Neck tab inspired by the Porsche 917 'Hippie'. 100% cotton. In dark blue.

WAP55100S-3XL0LMRH



Women's T-shirt – MARTINI RACING®

Short-sleeve T-shirt with feminine V-neck in dark blue/green. Side seams embellished with the typical MARTINI RACING® colors. 'MARTINI RACING® PORSCHE' badge on the chest and badge with number 3 on the upper arm. 'PORSCHE' logo printed on the back. Collar patch inspired by Porsche 917 'Hippie'. 100% cotton. In blue.

WAP5520XS-XXL0LMRH

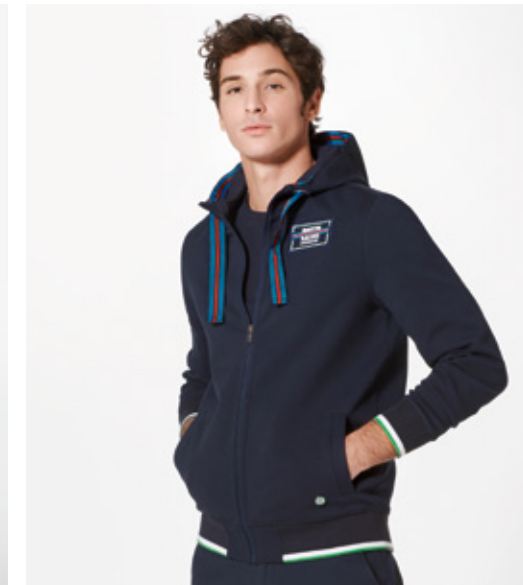

Men's sweat jacket – MARTINI RACING®

Sweat jacket with a hood and two side pockets in dark blue, with Porsche 917 'Hippie' color accents in blue and green. Cords and hem on the hood in typical MARTINI RACING® colors. 'MARTINI RACING® PORSCHE' badge on the chest, number 3 badge on the upper arm and 917 pin on the hem. 75% cotton, 20% polyester, 5% elastane. In dark blue.

WAP55600S-3XL0LMRH



**Men's reversible quilted jacket –
MARTINI RACING®**

A modern lightly padded and reversible quilted jacket with hood. With a chest pocket and two side pockets. Wind and water-repellent. Details in typical MARTINI RACING® colors. 'MARTINI RACING® PORSCHE' badge on the chest, number 3 badge on the upper arm and 917 pin on the hem. The inside is inspired by the Porsche 917 'Hippie'. Blue outer material: 100% nylon. Patterned outer material: 100% polyester. In blue, green and white.

WAP55900S-3XL0LMRH



**Women's reversible quilted jacket –
MARTINI RACING®**

A modern, lightly padded and reversible quilted jacket with hood. With a chest pocket and two side pockets. Wind and water-repellent. Details in typical MARTINI RACING® colors. 'MARTINI RACING® PORSCHE' badge on the chest, number 3 badge on the upper arm and 917 pin on the hem. The inside is inspired by the Porsche 917 'Hippie'. Blue outer material: 100% nylon. Patterned outer material: 100% polyester. In blue, green and white.

WAP5580XS-XXL0LMRH





Unisex baseball cap – MARTINI RACING®

Baseball cap with MARTINI RACING® embroidery on the front and 'PORSCHÉ' embroidery on the back. Infinitely adjustable strap in traditional MARTINI RACING® colors. Inspired by the Porsche 917 Long Tail MARTINI RACING® – better known as the Porsche 917 'Hippie' – there is an appliquéd number 3 and chequered flag on one side. 100% cotton. In dark blue/white.

WAP5500010LMRH



Unisex belt – MARTINI RACING®

A woven belt in the typical MARTINI RACING® colors. Infinitely adjustable. The buckle is embossed with the 'PORSCHÉ' logo. The ends of the belt are edged in leather. Leather on the buckle embossed with 'MARTINI RACING® PORSCHÉ' logo. Sizes: S [80cm], M [95cm], L [110cm] and XL [125cm]. Belt: 100% polyester. Buckle: 100% zinc alloy. In blue/red.

WAP557080-1250LMRH

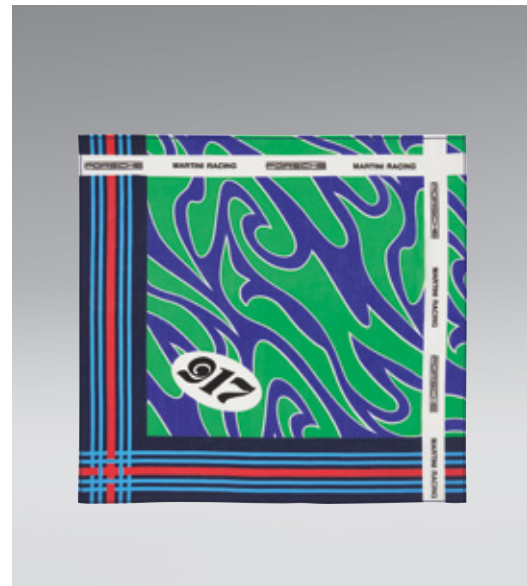

Unisex nicicloth – MARTINI RACING®

Nicicloth inspired by Porsche 917 'Hippie' and the original 'Hippie' scarf that Mary, the wife of Vic Elford, wore at Les Mans in 1971. This nicicloth can be worn as a neck scarf, head scarf or as decoration on a bag. 50 x 50cm. 100% cotton. In blue/green/white.

WAP5500060LMRH





Sunglasses P´8642 M – MARTINI RACING®

Modern and timeless stainless steel design boasting the MARTINI RACING® look. The 3D effect of the straight-edge concept creates a fascinating lighting effect. In Dark Blue with 'MARTINI RACING®' print on the frame. Glasses mirrored blue. Made in Italy.

WAP0786420KM62

Chronograph – MARTINI RACING®

Chronograph in MARTINI RACING® design. Swiss ETA movement with four stones. Black, metal dial face with the typical 'MARTINI RACING® PORSCHE' logo and stripes. Super-LumiNova on the hour and minute hands and numbers. Five-part, stainless steel case, finely satined. Waterproof up to 10ATM. Integrated stop function. Sapphire crystal with one-sided anti-reflective coating tube and crown screwed down and polished, with engraved Porsche Crest on the front surfaces. Metal strap with length regulating elements. Strap width: 22mm. Stainless steel pin clasp with engraved 'PORSCHE' logo. With high-value watch packaging. Height: 12mm. Diameter: 42mm. Swiss made.

WAP0700710LMRC

Sport Chrono – MARTINI RACING®

Chronograph featuring a MARTINI RACING® design. Swiss ETA movement with four jewels. With PowerDrive to increase the speed with which the hands move to more than 200Hz. Three-part stainless steel casing. Waterproof up to 10ATM. Milled grooves with separately inlaid design elements in black. Metal dial with MARTINI RACING® stripes. Sapphire glass with anti-reflection treatment on one side. Rubber strap in black with honeycomb structure on the top and tyre relief on the bottom. Stainless steel pin clasp with lasered 'PORSCHE' logo. Diameter: 42mm. Swiss made.

WAP0700020J

Cool bag – MARTINI RACING®

Spacious, waterproof cool bag with badges in MARTINI RACING® design. An additional compartment on the front can be closed with a zip; the length of the removable shoulder strap can be adjusted. In dark blue/light blue/white.

WAP0359290MOMR

Leisure bag – MARTINI RACING®

A modern sports bag in the popular MARTINI RACING® design with a 3D logo on the front and green details. Spacious main compartment with small inner pocket with zip for personal belongings. Two side pockets. With detachable shoulder strap. Outer material: 70% polyester, 30% acrylic. Lining: 100% polyester. In dark blue.

WAP0359270LOMR



Backpack – MARTINI RACING®

A modern backpack in the popular MARTINI RACING® design with a 3D logo on the front and green details. Spacious internal compartment with laptop compartment. Separate front pocket and hidden back pocket. With trolley link. Outer material: 70% polyester, 30% acrylic. Lining: 100% polyester. In dark blue.

WAP035926LOMR



Multipurpose case – MARTINI RACING®

Soft case in the beloved MARTINI RACING® design with green details. With diverse interior compartments for safe storage of belongings, such as headphones, a power bank or charging cables. 60% polyester, 40% nylon. In dark blue.

WAP035928LOMR



Unisex bathrobe – MARTINI RACING®

Hooded bathrobe in MARTINI RACING® design. With two patch pockets and high-quality MARTINI RACING® details, such as embroidery and a webbed patch on the upper sleeve. Belt embroidered with 'PORSCHE' logo. Outer made of soft velour, inner made of terry cloth. 100% cotton. In dark blue.

WAP55500S-3XLLOLMR



XL towel – MARTINI RACING®

Jacquard-woven fabric towel in MARTINI RACING® design. Dark blue upper in soft velour and underside in white terry cloth. With decorative sewn-on ribbon and loop in MARTINI RACING® colors. With Velcro pocket attached to the underside for personal effects [smartphone, keys, etc.]. Size: approx. 190 × 90cm. 100% cotton. In dark blue/white.

WAP5500050LOMR



Parasol and umbrella – MARTINI RACING®

Umbrella in MARTINI RACING® design – provides protection against rain and sun. Includes a sleeve with a practical shoulder handle for easy transport. Comfortable opening by means of a handy slide. High-quality windproof system for maximum frame flexibility, even in strong winds. Rails and two-piece pole made of stable fibreglass, lower pole with tip for fixing in the ground. Suitable for suitcases due to space-saving travel size.

WAP0500820MSMR



Umbrella XL – MARTINI RACING®

Large umbrella with double cover and MARTINI RACING® print motif from the 917 Longtail of 1971. With Dupont Teflon coating and silver-colored elements. Windproof system with fibreglass spokes. Plastic handle with '21' embossed on the bottom. Length [closed]: 88.5cm. Diameter: approx. 120cm. In dark blue.

WAP0505700J



Table clock – MARTINI RACING®

Design based on the Sport Chrono clock of Porsche vehicles. In MARTINI RACING® design. Alarm and countdown function. Alarm with engine sound. Analogue and digital time display. LCD display. Digital time display either in 12- or 24-hour format. Calendar display in two formats: day-month-year or month-day-year. Height: approx. 11.5cm. In black/white/dark blue/light blue/red.

WAP0701020KOMR

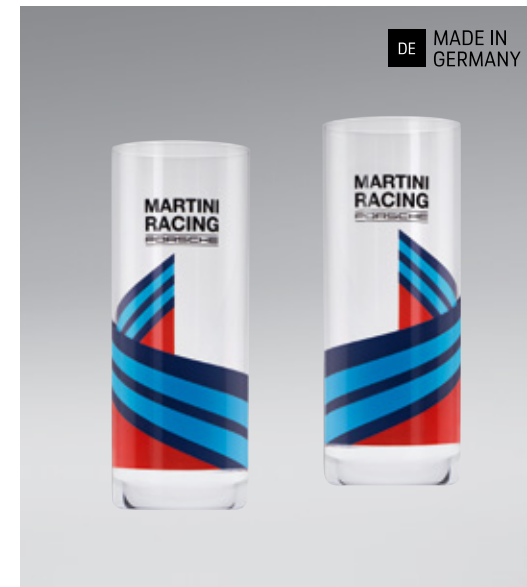

Two-piece set of long drink glasses – MARTINI RACING®

High-quality lead crystal glasses [machine-blown] in MARTINI RACING® design. Glass and refinement: motifs in the MARTINI RACING® colors. In blue/red/black. Made in Germany.

WAP0505000LOMR



Thermally insulated flask – MARTINI RACING®

Made of double-walled stainless steel. With MARTINI RACING® design in dark blue and stripes in light blue/red. Fastener inspired by Porsche central locking. Capacity: 1.0l.

WAP0500620LOMR



Thermos cup – MARTINI RACING®

High-quality thermo-insulated cup with MARTINI RACING® design. Made of double-walled stainless steel. Leakproof lid. Keeps hot drinks warm and cold drinks cool. Volume: approx. 0.45l. In dark blue/blue/red.

WAP0505500K



917 grille badge – MARTINI RACING®

Grille badge with image of the 917 KH MARTINI RACING® that took the second overall Porsche victory in the legendary 24-hour race at Le Mans in 1971. Diameter: 95mm. Made of 95% zinc, 5% acrylic varnish. Made in Germany.

WAP0508100MOMR



Grille badge – Limited Edition – MARTINI RACING®

Limited to 2,000 pieces. Diameter: 95mm. Made of metal. With fixing material [screws]. In dark blue/red/silver color. Made in Germany.

WAP0508100LOMR



Porsche seat barrel – MARTINI RACING®

Authentic barrel to be used as seating furniture. With MARTINI RACING® Design and padded seat. Suitable for indoor and outdoor use. Height approx. 60cm. Made in Germany.

WAP0501000MSFS



Snap-on case for iPhone 12 mini – MARTINI RACING®

iPhone case in typical MARTINI RACING® look. With 'MARTINI RACING®' and 'PORSCHE' logos, as well as the start number 22. Volume buttons as well as recesses for camera, speaker and microphone.

WAP0300100MSOC



Snap-on case for iPhone 12/12 Pro – MARTINI RACING®

iPhone case in typical MARTINI RACING® look. With 'MARTINI RACING®' and 'PORSCHE' logos, as well as the start number 22. Volume buttons as well as recesses for camera, speaker and microphone.

WAP0300110MSOC



Snap-on case for iPhone 12 Pro Max – MARTINI RACING®

iPhone case in typical MARTINI RACING® look. With 'MARTINI RACING®' and 'PORSCHE' logos, as well as the start number 22. Volume buttons as well as recesses for camera, speaker and microphone.

WAP0300160MSOC

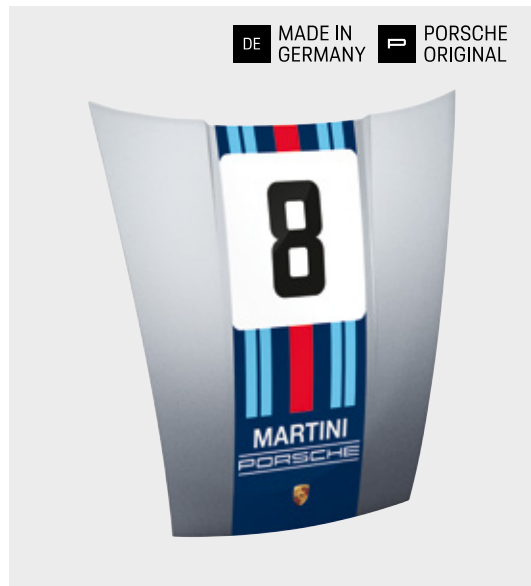

911 MARTINI RACING® Lollipop bonnet

Original bonnet of the historic Porsche 911 [G Series] with original historic Porsche Crest. Bonnet painted in Silver Metallic with high-quality MARTINI RACING® trim and start number 8. Magnetic. Includes hanging device and drilling template to mount on the wall. Dimensions: approx. 120 × 130cm. Weight: approx. 15kg. Made to order.

WAP0503020MMR1

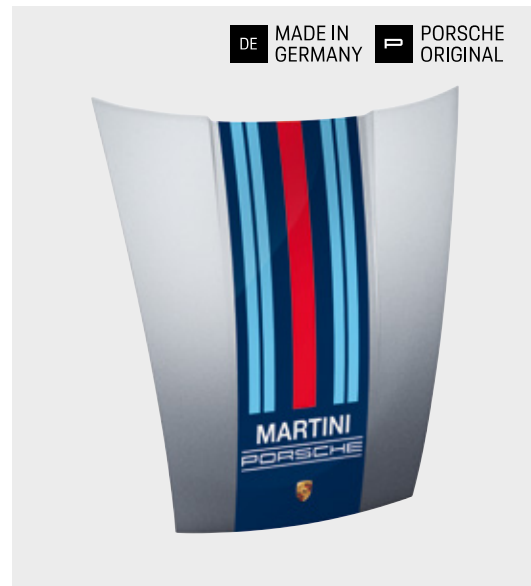

911 MARTINI RACING® bonnet

Original bonnet of the historic Porsche 911 [G Series] with original historic Porsche Crest. Bonnet painted in Silver Metallic with high-quality MARTINI RACING® trim. Magnetic. Includes hanging device and drilling template to mount on the wall. Dimensions: approx. 120 × 130cm. Weight: approx. 15kg. Made to order.

WAP0503030MMR1



Computer mouse – MARTINI RACING®

Wireless mouse with typical MARTINI RACING® look. Taillight strip illuminates when used. Ergonomically optimised shape. Made of plastic. In black/blue/red.

WAP0808100K



Lanyard – MARTINI RACING®

Lanyard with removable key ring and aeroplane buckle. In the typical MARTINI RACING® colors. Woven 'PORSCHE' logo. 'MARTINI RACING® PORSCHE' rubber badge. One large key ring and small key ring. Strap: 100% polyester. Carabiner: 100% zinc alloy. In blue/red.

WAP5500030LMRH





917 'Pink Pig' Collection

Original, unusual and steeped in history. The design of the new 917 'Pink Pig' Collection will bring a historic motorsport feeling straight to your home. And is a tribute to the legendary Porsche 917/20 that competed at Le Mans in

1971, where it caused quite a stir – not least because of its imaginative paintwork, the 'Pink Pig' design, that is also reflected on all the products in the new collection. And is guaranteed to turn every break into a pit stop.

LE LIMITED EDITION



Collector's cup no. 4 – Limited Edition – 917 'Pink Pig'

Collector's mug no. 4 in porcelain. Limited to 10,000 units. Exclusive Porsche porcelain shape inspired by the Porsche Crest. In the design of the legendary 917 'Pink Pig'. Design by Studio F. A. Porsche. In high-quality gift packaging. Dishwasher-safe.

WAP0506700M917

LE LIMITED EDITION



Collector's espresso duo no. 4 – Limited Edition – 917 'Pink Pig'

Limited to 5,000 units. Set consisting of two espresso cups and saucers. Exclusive Porsche porcelain shape inspired by the Porsche Crest. Design by Studio F. A. Porsche, inspired by the legendary 917 'Pink Pig'. In high-quality gift packaging. Dishwasher-safe.

WAP0506600M917

LE LIMITED EDITION



Set of two highball glasses – 917 'Pink Pig'

Set of two high-quality highball glasses in the design of the legendary 917 'Pink Pig'. Design by Studio F. A. Porsche. Volume per glass: approx. 450ml.

WAP0506800M917



Thermo-insulated flask – 917 'Pink Pig'

Thermo-insulated flask made of double-walled stainless steel in the design of the legendary 917 'Pink Pig'. Fastener inspired by Porsche central locking. Volume: approx. 1.0l.

WAP0506900M917



DE MADE IN GERMANY



Porsche seat barrel – 917 'Pink Pig'

Authentic barrel to be used as seating furniture. With 917 'Pink Pig' decal and padded seat. Suitable for indoor and outdoor use. Height approx. 60cm. Made in Germany.

WAP0501020MSFS



Poster set – 917 'Pink Pig'

Poster set consisting of two posters. Motif 1: 917/20 'Pink Pig'. Motif 2: exclusively designed racing poster 'Pink Pig back on track'. Dimensions: 50 × 70cm.

WAP0924500M917



'Pink Pig' fluffy blanket

Cuddly fluffy blanket in the shape of a pig and in the legendary 917 'Pink Pig' design.

WAP0400020MOST





Motorsport Replica Collection

Ready for a makeover? Not only has the Formula E team been rebuilt together with the car, but the team clothing has also been revised. True to the motto, 'Start from Zero'.

The Motorsport Replica Collection brings the style of the professionals directly to the fans, from head to toe. By the same token, the trainers designed by Puma and the cap are not strictly replicas, but rather original team wear of the Porsche team.

Every single member of the Porsche Motorsport family is ready to give everything to make up for the next hundredth of a second with one more idea and a little extra effort. A principle that the Replica Collection consistently pursues. The Porsche Motorsport Kit for the race track is available for all clothing in the collection. This includes a glasses strap, earplugs and phone popper, with which your mobile phone is always ready for the next snapshot, even during the most euphoric fan cheers.



Knitted pullover – Motorsport Replica

Half-zip pullover with stand-up collar. Based on the original Porsche Motorsport team clothing. Porsche Motorsport and Hugo Boss logos embroidered on the chest. Michelin and Mobil1 logos embroidered on the upper arm. Hugo Boss logo embroidered on the back.

WAP1210XS–3XL0MMSR



Winter jacket – Motorsport Replica

Long, padded jacket. Stay warm regardless of the wind or weather. Water column 5,000mm and breathability 5,000g/m²/24h. Lined, detachable hood with elasticated drawstring, Velcro fastener and decorative reflective print detail. Two-way zip on the front with wind protection strip and Velcro fastener. Two side pockets, concealed chest pocket and inner pocket with zip. Sleeve hem with double cuffs, adjustable Velcro fastener and decorative reflective print detail. Porsche Motorsport and Hugo Boss logos on the chest and back. Michelin and Mobil1 logo on the upper arm. Hugo Boss and a large Porsche logo on the back.

WAP12000S–3XL0MMSR



Cap – Formula E

Original Formula E Porsche team cap. With Velcro fastener and a host of sponsor logos [TAG Heuer, ABB, Vodafone and Puma]. One-size-fits-all.

WAP8800010MFME



Men's polo shirt – Motorsport Replica

Short-sleeved polo shirt in piqué with three buttons and 'PORSCHE MOTORSPORT' signet. Design based on the original Porsche Motorsport team clothing. With 'PORSCHE' logo on the shoulder yoke. Includes Motorsport Kit with phone popper, glasses strap and earplugs for the race track. 95% cotton, 5% elastane.

WAP43200S-3XL0LOMS
[black, with zipped chest pocket],
WAP43000S-3XL0LOMS [white]



Women's polo shirt – Motorsport Replica

Short-sleeved polo shirt in piqué with three buttons and 'PORSCHE MOTORSPORT' signet. Design based on the original Porsche Motorsport team clothing. With 'PORSCHE' logo on the shoulder yoke. Including Motorsport Kit with phone popper, glasses strap and earplugs for the race track. 95% cotton, 5% elastane.

WAP4340XS-XXL0LOMS
[black, with zipped chest pocket],
WAP4310XS-XXL0LOMS [white]





Men's softshell jacket – Motorsport Replica

Softshell jacket with stand-up collar, zipped side pockets and fleece inner. Design based on the original Porsche Motorsport team clothing. Water column 5,000mm, breathability 5,000g/m²/24h, side pockets with zip. Includes Motorsport Kit with phone popper, glasses strap and earplugs for the race track. 100% polyester. In black/white.

WAP43500S-3XL0L0MS



Women's softshell jacket – Motorsport Replica

Softshell jacket with stand-up collar, zipped side pockets, fleece inner and cuff-adjusters. Design based on the original Porsche Motorsport team clothing. Water column 5,000mm, breathability 5,000g/m²/24h, side pockets with zip. Includes Motorsport Kit with phone popper, glasses strap and earplugs for the race track. 100% polyester. In black/white.

WAP4360XS-XXL0L0MS



Unisex jacket – Motorsport Replica

Raincoat with stand-up collar and storable hood. Design based on the original Porsche Motorsport team clothing. Water column 5,000mm, breathability 5,000g/m²/24h, side, chest and inner pockets with zip. Includes Motorsport Kit with phone popper, glasses strap and earplugs for the race track. 100% polyester. In black/white.

WAP4380XS-3XL0L0MS



Unisex softshell gilet – Motorsport Replica

Softshell gilet with stand-up collar, zipped side pockets and fleece inner. Design based on the original Porsche Motorsport team clothing. Water column 5,000mm, breathability 5,000g/m²/24h, side pockets with zip. Includes Motorsport Kit with phone popper, glasses strap and earplugs for the race track. 100% polyester. In black/white.

WAP4370XS-3XL0L0MS



Baseball cap – Motorsport Replica

Baseball cap with Velcro fastener. Design with 'PORSCHE MOTORSPORT' signet and Puma logo based on the original Porsche Motorsport team clothing. 100% polyester. In white.

WAP4300010L0MS



Unisex trainers – Motorsport Replica

Original trainers of the Porsche Motorsport teams. One-piece, seamless knitted mesh upper for lightness and breathability. Bootie-fit construction with special inner shoe construction for maximum comfort thanks to a personalised fit. With integrated Engineered Stability Zone in the two-layer midsole for optimal stability, highly effective cushioning that returns energy with every step, and antimicrobial, breathable EcoOrthoLite® insole. 50% rubber, 30% polyester, 20% polyurethane. In black.

WAP43938-470L0MS



Motorsport Fanwear Collection

The race track offers exactly the right conditions for Porsche to prove itself over and over again. New fanwear from Porsche Driver's Selection is also being launched. Ultimately, we want to support our team as best we can. Because whether petrol or E-Performance: motorsport is and remains a team sport.

The sporty T-shirts, sweatshirts, jackets and accessories boast a simple design that can also be seen away from the race track in any of the 12 cities. The characteristic black, red and white colors determine the look, making it unmistakable among motorsport fans. And the new collection also includes a flag for a fitting fan celebration, of course.



Men's polo shirt – Motorsport Fanwear

Polo shirt in jersey with three buttons and 'PORSCHE MOTORSPORT' signet. With red piping on the shoulder yoke. 95% cotton, 5% elastane.

- WAP80100S-3XL0LFMS [white],
- WAP80200S-3XL0LFMS [black],
- WAP80300S-3XL0LFMS [grey]

Women's polo shirt – Motorsport Fanwear

Polo shirt in jersey with three buttons and 'PORSCHE MOTORSPORT' signet. Tonal, vertical 'PORSCHE' logo on the back. 95% cotton, 5% elastane.

- WAP8040XS-XXL0LFMS [red],
- WAP8050XS-XXL0LFMS [grey],
- WAP8060XS-XXL0LFMS [black]



Men's polo shirt – Motorsport Fanwear

Polo shirt in jersey with three buttons and 'PORSCHE MOTORSPORT' signet. With red piping on the shoulder yoke. 95% cotton, 5% elastane.

WAP80700S-3XL0LFMS [white],
WAP80800S-3XL0LFMS [black],
WAP80900S-3XL0LFMS [grey]

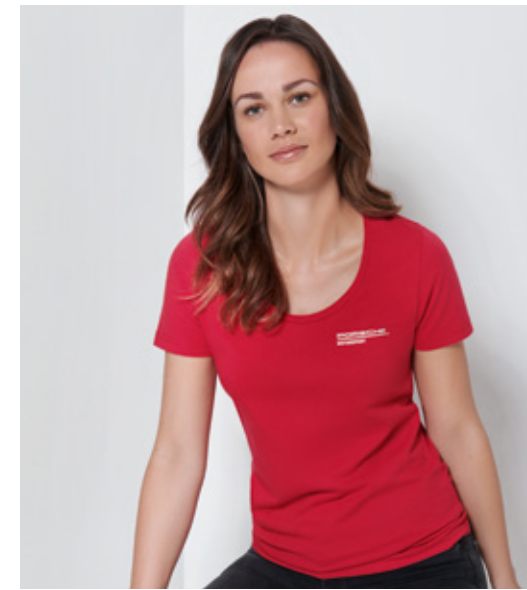

Women's T-shirt – Motorsport Fanwear

Short-sleeved T-shirt in jersey with three buttons and 'PORSCHE MOTORSPORT' signet. Tonal, vertical 'PORSCHE' logo on the back. 95% cotton, 5% elastane.

WAP8100XS-XXL0LFMS [red],
WAP8110XS-XXL0LFMS [grey],
WAP8120XS-XXL0LFMS [black]

New



Women's polo shirt – Motorsport Fanwear

Short-sleeved polo shirt with three buttons and V-shaped piping. 'PORSCHE MOTORSPORT' signet on the front and tonal Porsche logo on the back. 95% cotton, 5% elastane. In black/red.

WAP126XXX0NFMS

New



Men's polo shirt – Motorsport Fanwear

Short-sleeved polo shirt with two buttons. 'PORSCHE MOTORSPORT' signet on the front and tonal Porsche logo on the back. Mesh insert on the shoulders and sleeves. 95% cotton, 5% elastane. In black/red.

WAP125XXX0NFMS

New



Women's jacket – Motorsport Fanwear

Light softshell jacket with stand-up collar and 'PORSCHE MOTORSPORT' signet. Warm fleece lining. Mesh insert on the shoulders and upper arms. Sporty dividing seams and V-shaped piping. With two side pockets and two breast pockets with zips. 86% polyester, 14% elastane. In red/black.

WAP121XXX0NFMS

New



Men's jacket – Motorsport Fanwear

Lightweight softshell jacket with stand-up collar and 'PORSCHE MOTORSPORT' signet. Warm fleece lining. Mesh insert on the shoulders and upper arms. Sporty dividing seams and V-shaped piping. With two side pockets and two breast pockets with zips. 86% polyester, 14% elastane. In black/red.

WAP120XXX0NFMS

New



T-shirt – Motorsport Fanwear

Short-sleeved T-shirt with crew neck and original Formula E team logo. In black.

WAP128XXX0NFMS

New



Jacket – Motorsport Fanwear Collection

Lightweight stretch jacket with multiple Formula E team logos. With warm fleece lining, two side pockets with zips and stand-up collar. Unisex. In red/white/black.

WAP127XXX0NFMS

New



Unisex hoodie – Motorsport Fanwear

Casual hoodie adorned with large 'PORSCHE MOTORSPORT' signet. With pocket and sporty dividing seams. Mesh insert on the shoulders and upper arm.

WAP124XXX0NFMS

New



Unisex windbreaker – Motorsport Fanwear

Lightweight windbreaker with drawstring hood. Hem with adjustable elasticated band made from tear-resistant ripstop material. Side pockets and one upper arm pocket with zip. With mesh lining. Outer fabric: 100% polyamide. Sleeve lining: 100% polyester. Body and hood lining: 100% polyester. In black/red.

WAP123XXX0NFMS



Men's sweat jacket – Motorsport Fanwear

Sweat jacket with 'PORSCHE MOTORSPORT' signet. With two side slip pockets, tonal 'PORSCHE' logo on the shoulder yoke and button with 'PORSCHE' logo on the upper arm. 70% cotton, 30% polyester. In black.

WAP81400S-3XL0LFMS

New



Drinking bottle – Motorsport Fanwear

Semi-transparent drinking bottle with screw cap and 'PORSCHE MOTORSPORT' signet. Ideal for on the road and on the race track. Capacity: approx. 735ml. Dishwasher-safe.

WAP0501270NFMS





Laser key ring – Motorsport Fanwear

Key ring in stainless steel with lasered 'PORSCHE MOTORSPORT' signet. 90% zinc alloy, 10% metal. In silver color.

WAP0500060LFMS [tonal laser logo],

WAP0500050LFMS [colored logo, printed and glazed]

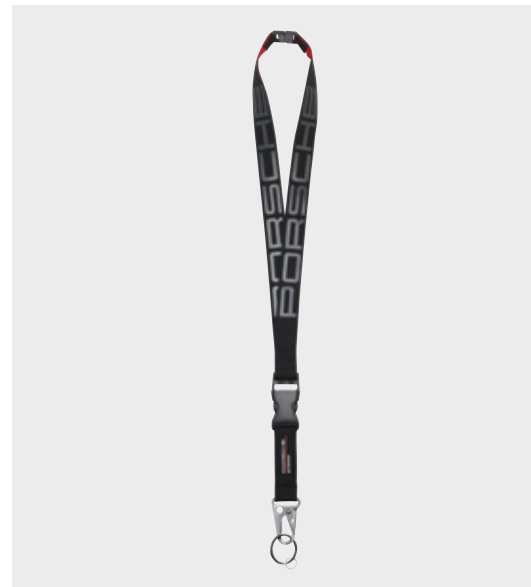

Lanyard – Motorsport Fanwear

Lanyard with 'PORSCHE' logo and safety breakaway clip. Including removable key ring with 'PORSCHE MOTORSPORT' signet. 80% polyester, 10% plastic, 10% metal. In black.

WAP0500030LFMS



Baseball cap – Motorsport Fanwear

Perforated five-panel baseball cap with snap-back fastener and 'PORSCHE MOTORSPORT' signet. At the back, there is a button with 'PORSCHE' logo in the middle. 100% polyester.

WAP8000010LFMS [black],

WAP8000020LFMS [red],

WAP8000030LFMS [white]



Backpack – Motorsport Fanwear

Backpack with laptop slide-in compartment. Front compartment with zip pockets and spacious mesh pockets on the sides. Padding on the straps and back. With 'PORSCHE MOTORSPORT' signet. 100% polyester. In black.

WAP0350030LFMS



Sports bag – Motorsport Fanwear

Sports bag with large main and separate shoe compartment. With padded shoulder strap. With 'PORSCHE MOTORSPORT' signet. 100% polyester. In black.

WAP0350020LFMS



Pull bag – Motorsport Fanwear

Lightweight backpack in classic gym bag design with drawstring shoulder strap. With exterior zip pocket and 'PORSCHE MOTORSPORT' signet. 100% polyester. In black.

WAP0350010LFMS



Flag – Motorsport Fanwear

Fan flag with 'PORSCHE MOTORSPORT' signet. Dimensions: 90 x 60cm. 100% polyester. In black. Made in Germany.

WAP0500070LFMS



Heritage Collection

Trends come and go. Style remains. A fact that is also proven by the new 911 Targa 4S Heritage Design Edition, which pays homage to the roots of the Porsche brand and, with its many historical design details, brings a piece of sports car history back onto the streets of today.

The Heritage Collection is based on this Porsche special edition, proving that the 50s had much more to offer than just petticoats, sheath dresses, blue jeans and leather jackets. With gorgeous colors and golden accents, it breathes retro into your everyday life – but adds a modern twist.

911 Targa 4S Heritage Design Edition: fuel consumption in l/100km: urban 15.0–13.3 · extra urban 8.0–7.6 · combined 10.3–9.9 [NEDC]; combined 11.1–10.4 [WLTP]; CO₂ emissions in g/km combined: 235–227 [NEDC]; 253–236 [WLTP]



Men's polo shirt – Heritage

Polo shirt for men with iridescent effect thanks to two-tone piqué in Bordeaux Red and blue. With three buttons. Gold-colored Porsche stitching on chest and neck. Porsche Heritage label at the hem. 50% cotton, 50% polyester.

WAP32000S-3XL0LHRT



Women's polo shirt – Heritage

Polo shirt for women with iridescent effect thanks to two-tone piqué in Bordeaux Red and blue. With collar and feminine V-neck. Gold-colored Porsche stitching on chest and neck. Porsche Heritage label at the hem. 50% cotton, 50% polyester.

WAP3210XS-XXL0LHRT



LE LIMITED EDITION

Collector's T-shirt no. 19 Unisex – Limited Edition – Heritage

A tribute to the 1950s and the new 911 Targa 4S Heritage Design Edition: the Collector's shirt with print design. Packaged in an exclusive metal box printed with the same motif. Includes a postcard explaining the print. Very soft quality T-shirt. 100% cotton. In dark grey.

WAP3250XS-3XL0LHRT

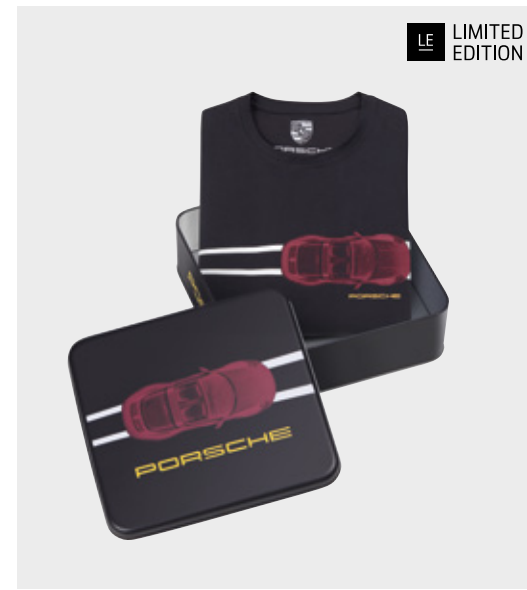

LE LIMITED EDITION



Men's jacket – Heritage

Lightly padded bomber jacket with two patch pockets and baseball collar. Additional pocket on upper arm and inner pocket with zip. Decorative details in Bordeaux Red, gold color and black. Gold-colored Porsche stitching on chest and neck. Porsche Heritage story label in the jacket. 100% polyester, lining: 100% nylon. In Bordeaux Red. Add-on: card holder in leather with carabiner for attaching to interior pocket. 100% leather.

WAP32200S-3XL0LHRT



Women's jacket – Heritage

Sporty-chic, lightly padded bomber jacket with two patch pockets and baseball collar. Additional pocket on upper arm and inner pocket with zip. Decorative details in Bordeaux Red, gold color and black. Gold-colored Porsche stitching on chest and neck. Porsche Heritage story label in the jacket. Outer fabric and padding: 100% polyester, lining: 100% nylon. In beige. Add-on: card holder in leather with carabiner for attaching to interior pocket.

WAP3230XS-XXL0LHRT



Sunglasses P'8508 – Heritage

Retro style, modern interpretation: stainless-steel aviators from Porsche Design with ultra flexible temples. In stainless steel. With 'Porsche Design' logo on the lens and temples. In gold color/Bordeaux Red. Made in Italy.

WAP0785080LHRT



Weekender – Heritage

Modern canvas weekender bag inspired by the Porsche 911 Targa 4S Heritage Design Edition. Porsche logo and other accents in gold color. High-quality leather straps and adjustable shoulder strap. Inside zip compartment. Including three separate inner pockets for shoes, shirts and accessories. 35% linen, 40% cotton, 25% cowhide leather. In Anthracite. Made in Italy.

WAP0350110LHRT



Women's purse – Heritage

Purse in high-quality cowhide leather with embossed Porsche logo and zip. Large interior coin compartment with zip and various other compartments. Two banknote compartments. 60% cowhide leather, 30% polyester, 10% microfibre. In Asphalt Grey with detailing in Bordeaux Red. Made in Europe.

WAP0300340LHRT





Men's wallet – Heritage

Wallet in high-quality cowhide leather with embossed Porsche logo. With coin and various other compartments. Banknote compartment with divider. 60% cowhide leather, 30% polyester, 10% microfibre. In Asphalt Grey with detailing in Bordeaux Red. Made in Europe.

WAP0300350LHRT



Credit card case – Heritage

Credit card case in high-quality cowhide leather with embossed Porsche logo. With eight compartments for credit cards and additional compartments. Banknote compartment with divider. Made in Europe. 60% cowhide leather, 30% polyester, 10% microfibre. In Asphalt Grey with detailing in Bordeaux Red. Made in Europe.

WAP0300360LHRT



Crest key ring – Heritage

Real leather. Suitable for all Porsche vehicle keys. Including gift packaging. Ring: brass. In beige, gold color. Made in Germany.

WAP0500900LHRT



Men's leather gloves – Classic

Men's driving gloves with double-row perforations on front and back. Four notches, secured with stitches, at each knuckle. Back of the glove with press stud made of antique brass and 'PORSCHE' logo. No lining. 100% nappa lambskin. In black. Available in sizes S, M and L.

WAP519001-0030H



Women's leather gloves – Classic

Women's driving gloves with all-over perforation on the back of the glove and smooth-finish leather on the palm. Four notches with piped seam at each knuckle. Back of the glove with press stud made of antique brass and 'PORSCHE' logo. No lining. 100% nappa lambskin. In black. Available in sizes S, M and L.

WAP518001-0030H



917 Salzburg Collection

Show your true colors. But not just to anybody, to none other than the Porsche 917 which, bearing the number 23, brought home the first Le Mans victory for Porsche against all odds.

The 917 Salzburg Collection pays homage to this legendary race and its winner: it not only evokes its red and white paintwork and start number, but its sporty, modern designs has a little something for everyone – no matter your age. Show off your fascination for the living legend – and put your foot down. Whether in everyday life, in your free time, on the road or at home.



Men's polo shirt – 917 Salzburg

Short-sleeved polo shirt with three buttons and 'PORSCHE' print on the chest. '23' decorative stitching on the sleeve. 'PORSCHE' and '917' print on the back. Piqué. 100% cotton. In red/white/black.

WAP46200S-3XL0MSZG



Men's T-shirt – 917 Salzburg

Short-sleeved T-shirt for men with Porsche logo on the chest and back. '917' print on the back. '23' decorative stitching on the right sleeve. 100% cotton. In red/white/black.

WAP46000S-3XL0MSZG



Sunglasses P ' 8642 – 917 Salzburg

Modern, timeless sunglasses from Porsche Design in 917 Salzburg Collection look. In stainless steel. In red/white with 'Porsche Design' logo on the lens and temples. Lenses: silver mirrored. Made in Italy.

WAP0786420M917

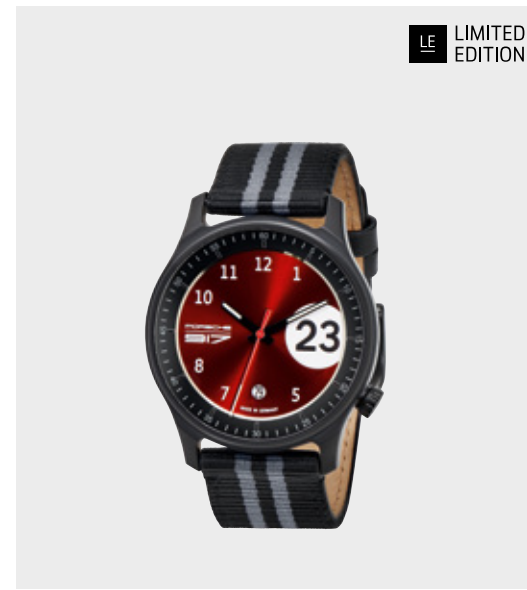

Pure Watch – Limited Edition – 917 Salzburg

Limited to 1,917 units. Three-hand watch with Swiss parts movement. Waterproof up to 5ATM. Stainless steel with black PVD coating. Mineral glass with anti-glare coating on one side. Red metal dial with the familiar white racing 'lollipop' and black start number 23. Porsche 917 logo at 9 o'clock, date display at 6 o'clock. Black/Anthracite fabric strap. PVD-coated stainless steel clasp with engraved 'PORSCHE' logo. Strap assembly with two spring pins. Design by Studio F. A. Porsche. With high-quality watch packaging. Diameter: 42mm. Made in Germany.

WAP0700030M917

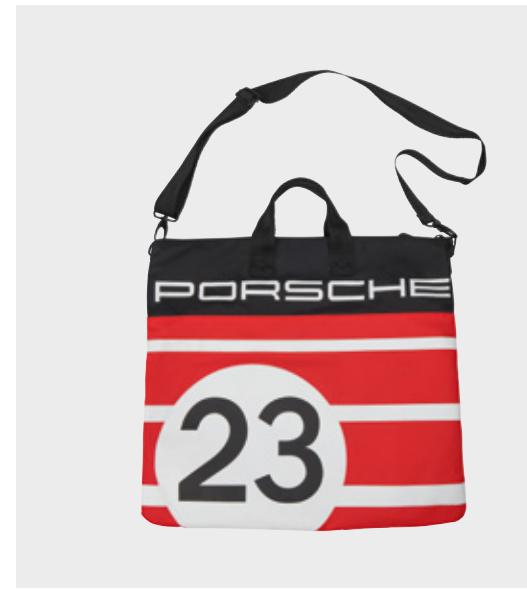

Bag – 917 Salzburg

Sporty bag with print design inspired by the Porsche 917 Salzburg which offers plenty of space for a helmet. Helmet bags were designed to protect helmets from scratches, and went hand in hand with the development of hard shell helmets in the 1950s. A carabiner was used to hang the bag so that it stayed open, allowing the helmet to be ventilated. With two patch pockets and an inner pocket with zip. With detachable shoulder strap and handles. Water-repellent. Durable nylon material: 100% polyamide. Dimensions: approx. 46 x 48cm. Unisex. In red/white/black.

WAP0354600MSZG



Kids' polo – 917 Salzburg

Short-sleeved polo shirt with three buttons and 'PORSCHE' print on the chest. With '23' badge on the sleeve. 'PORSCHE' and '917' print on the back. Piqué. In 100% cotton. In red/white/black.

WAP463098-1640MSZG



Kids' T-shirt – 917 Salzburg

Short-sleeved T-shirt for children with '917' appliqué and 'PORSCHE' print in white. Soft jersey material: 50% cotton and 50% polyester. Unisex. In grey melange.

WAP461 098-1640MSZG



Kids' hoodie – 917 Salzburg

Hoodie for children. With '917' appliqué and 'PORSCHE' print in white. Soft sweater material in 60% cotton and 40% polyester. Unisex. In grey melange.

WAP464098-1640MSZG



Kids' cap – 917 Salzburg

Stylish baseball cap for children. Front panel printed with the Porsche 917 Salzburg logo. Top of visor with white print design, inspired by the Porsche 917 Salzburg paintwork. Side print with numbers '23' and '917'. With freely adjustable Velcro fastener in black to adjust the size. Material: 100% cotton. In grey melange/black/red.

WAP4600010MSZG



Baby set – 917 Salzburg

Baby set including gift packaging – inspired by the Porsche 917 Salzburg. Bib, T-shirt and trousers with appliqués. One size available [62/68]. Made of soft cotton jersey: 62% polyester, 35% cotton, 3% elastane. In grey melange/black/red.

WAP4650020MSZG

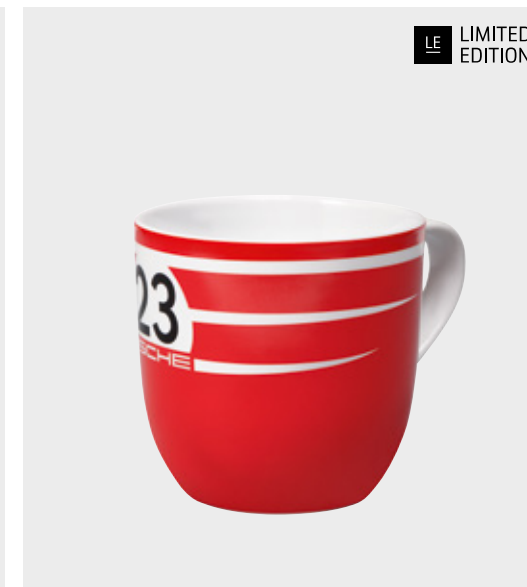

Collector's Cup no. 3 – Limited Edition – 917 Salzburg

Collector's mug no. 3 celebrating the 50th anniversary of the 917 Salzburg. Made of porcelain. Limited to 10,000 units. Exclusive Porsche porcelain shape inspired by the Porsche Crest. Design by Studio F. A. Porsche and in the look of the overall winner of the 24h of Le Mans 1970 with start number 23. In red/black/white – the original racing colors. With high-quality gift packaging. Dishwasher-safe. Made in Germany.

WAP0506040M917

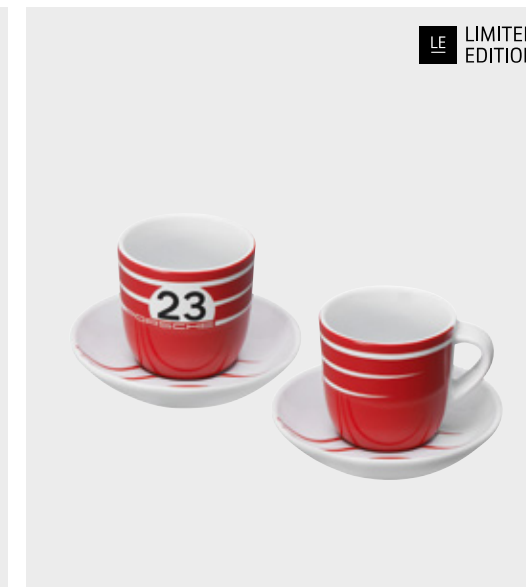

Collector's Espresso Duo no. 3 – Limited Edition – 917 Salzburg

Limited to 5,000 units. Set consisting of two espresso cups and saucers celebrating the 50th anniversary of the 917 Salzburg. Exclusive Porsche porcelain shape inspired by the Porsche Crest. Design by Studio F. A. Porsche and inspired by the look of the overall winner of the 24h of Le Mans 1970 with start number 23. In red/black/white – the original racing colors. In high-quality gift packaging. Dishwasher-safe. Made in Germany.

WAP0506050M917

DE MADE IN GERMANY



Grille badge – 917 Salzburg

Diameter: 95mm. Made of 95% zinc, 5% acrylic varnish. With fixing material [screws]. In red/white – like its motorised role model. Made in Germany.

WAP0509170MSZG

DE MADE IN GERMANY



Porsche seat barrel – 917 Salzburg

Authentic barrel to be used as seating furniture. With 917 Salzburg design and padded seat. Suitable for indoor and outdoor use. Height approx. 60cm. Made in Germany. WAP0501010MSFS

DE MADE IN GERMANY P PORSCHE ORIGINAL



911 Salzburg bonnet

Original bonnet of the historic Porsche 911 [G Series] with original historic Porsche Crest. Red with high-quality decoration in the style of the legendary 917 Salzburg livery. Magnetic. Includes hanging device and drilling template to mount on the wall. Dimensions: approx. 120 × 130cm. Weight: approx. 15kg. Made to order.

WAP0503010MSFB

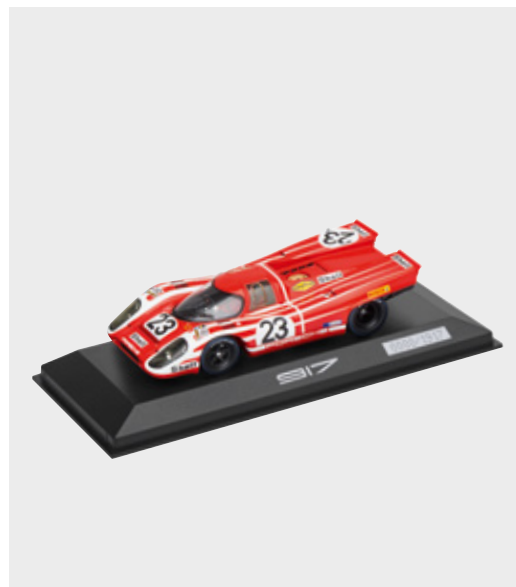

917 Salzburg – 1:43

In red/white. Interior in black. Made of resin. Scale 1:43.

WAP0209400M917

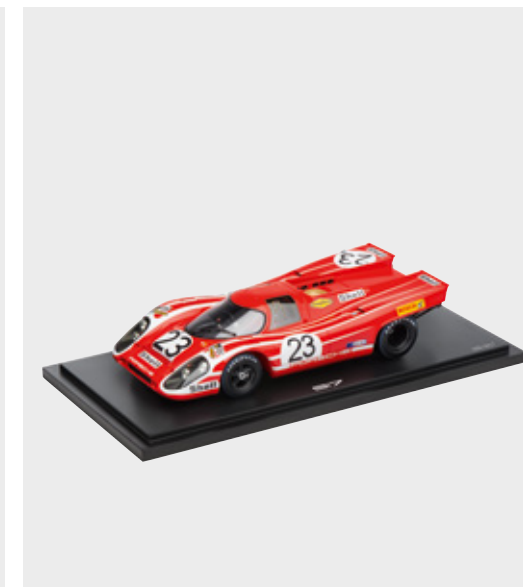

917 Salzburg – 1:18

In red/white. Interior in black. Made of resin. Scale 1:18.

WAP0219400M917



Turbo Collection

Relentless. And also sporty, powerful and focused on the essentials. These are all characteristics that can be attributed to the new 911 Turbo S in GT Silver Metallic as well as the new Turbo Collection. Because the sporty elegance and concentrated power of the vehicle is also reflected in the collection. Here, reduced colors meet uncompromising details – and highlight what is important: the 'turbo' logo.

911 Turbo S: fuel consumption in l/100km: urban 15.5 · extra urban 8.6 · combined 11.1 [NEDC]; combined 12.3–12.0 [WLTP]; CO₂ emissions in g/km combined: 254 [NEDC]; 278–271 [WLTP]



Unisex Sweatshirt – Turbo

Crew-neck sweatshirt with 'turbo' logo. Side seams run towards the front in a V-shape. Dividing seam under the chest. With decorative reflective 'turbo' and 'PORSCHE' print on the chest. 75% cotton, 21% polyester, 4% elastane. In dark blue.

WAP2180XS-3XL0LTRB





Unisex jacket – Turbo

Functional jacket with a color gradient on the front and hood, inspired by the Porsche 911 Turbo S. All stitching is bonded. Water column 5,000mm, breathability 5,000g/m²/24h. This jacket therefore provides particularly good protection from wind and rain. With decorative reflective 'turbo' and 'PORSCHE' print. With two side pockets. With chest and inner pocket. Inner pocket has an opening for headphones. With ventilation slots in the side seam. Half of the seam and side hem is provided with an elasticated cuff. Hood with internal drawstring stoppers. No lining. 100% nylon. In dark blue.

WAP2170XS-3XL0LTRB



Classic chronograph – Turbo

Classic chronograph with RONDA movement and four jewels. Silver-colored metal dial with details in blue and red, plus the 'turbo' logo. Sapphire crystal with anti-reflection coating on one side. Stainless steel case with a fine satin finish. Waterproof up to 10ATM. Tube and crown screwed and polished. Night Blue fabric strap with length adjustment. Strap width: 22mm. Stainless steel clasp with engraved 'PORSCHE' logo. Design by Studio F. A. Porsche. With high-quality watch packaging. Height: 12mm. Diameter: 44mm. Swiss made.

WAP0700880LCLC



Unisex slipper – Turbo

Strap featuring 'turbo' embossing, 'PORSCHE' logo in silver color and lined with mesh. Pre-formed footbed. Lightweight and comfortable. Ideal for travel, sport and relaxation. Available in sizes 36–47. Upper material: 100% polyurethane. Lining: 100% polyester. Sole: 100% ethylene vinyl acetate. In dark blue.

WAP215036-0470LTRB



Transaxle Collection

Courage to stand out from the crowd always comes from within. The new Transaxle Collection confirms this. It brings the flair of the 70s and 80s back to the road, and is dedicated to very special cult sports cars: the transaxle models.

Whether 924, 928, 944 or 968 – the transaxle models show courage and attract attention through their exterior. The new Transaxle Collection takes the colors and patterns of the interior – from the striking Pascha pattern to colorful tartan, which bring them back to the present day.

The sock box, for example, is modelled on the patterns, while innovative printing techniques are used in the tops to create many a surprise. After all, that's what their sports car role models did best.



Men's short-sleeved T-shirt – Transaxle Collection

Short-sleeved T-shirt. There is a 3D print design on the chest, which shows two different motifs depending on the perspective. 100% cotton. In Bordeaux Red.

WAP44000S-3XL0L924



Men's sweat jacket – Transaxle Collection

Sweat jacket with baseball collar and two side pockets. Top of arm with two-tone ribbed structure in light grey/dark blue. 3D print design on the back that shows two different motifs depending on angle. 70% cotton, 24% polyester, 6% elastane. In dark blue.

WAP44200S-3XL0L924





Sweat jacket – Transaxle Collection

Twill-look sweat jacket. The design is a tribute to the modern classic, the Porsche 928. With shirt collar, press studs, two side pockets and one inner pocket. 'PORSCHÉ' logo on the left chest. Upper sleeve decorative bands embossed with the part number of the original 928 fan belt. 79% polyester, 18% cotton, 3% elastane. In mottled grey.

WAP4240XS-3XLOKHTP



Baseball cap, unisex – Transaxle Collection

Five-panel baseball cap. Front panel with HD printing and 'PORSCHÉ' logo. The number 924 embroidered on the side. Print design on the underside of the peak inspired by the upholstery of the Porsche 924. With adjustable, fabric back strap and metal clasp with 'PORSCHÉ' logo. One size. Unisex. In dark blue. 60% cotton, 40% polyester. In dark blue.

WAP4400010L924



Four-pack sock box, unisex – Transaxle Collection

Porsche socks box with four pairs of socks inspired by the interior of the Porsche transaxle models 924, 928, 944 and 968: pinstripe, tartan, Pascha and herringbone. Vein-friendly sensitive cuff. Pressure-free hand-linked tip. Available sizes: 36/38-48/50. 100% cotton. In black/blue/Bordeaux Red/grey.

WAP445038-0500L924



Lanyard – Transaxle Collection

Lanyard inspired by the look of the Porsche 928 fan belt. With printed 'PORSCHÉ' logo and original part number. Includes carabiner, key ring and safety clasp. Strap: 100% polyester. Metal carabiner with plastic clasp. In black/white.

WAP4200030KHTP



Baseball cap – Transaxle Collection

Classic six-panel baseball cap. With embroidered '944' logo and pasha design on the bottom of bill. 100% cotton. In grey/red.

WAP4200010K



Essential Collection

Sporty cut, intelligent details, high-quality materials and careful workmanship turn the clothes from the Porsche Driver's Selection into exclusive favourite pieces for every day. Whether an elegantly interpreted Crest, a particularly finely stitched 'PORSCHE' logo, incorporated in the lining or completely restrained tone in tone.

These fashion basics can therefore be ideally combined, adding small accents to any outfit and reflecting sports car enthusiasm.

911 Carrera 4S: fuel consumption [in l/100km] urban 14.8–13.4 · extra urban 7.4–7.8 · combined 10.1–9.7 [NEDC]; combined 11.1–10.2 [WLTP]; CO₂ emissions [in g/km] combined: 231–222 [NEDC]; 253–231 [WLTP]



Men's Crest polo shirt

Piqué polo shirt with side slit and slightly longer rear. Buttons with 'PORSCHE' logo. High-quality embroidered Porsche Crest on the chest. 100% cotton.

WAP59100S-3XLOB [white],
WAP59200S-3XLOB [black]



Men's Crest T-shirt

Sporty short-sleeved T-shirt with large Porsche Crest in a matt, tonal print on the chest for men. 100% cotton. In black.

WAP82100S-3XL0K



Women's T-shirt – Porsche Crest

Porsche Crest trimmed with black rhinestones. 95% cotton, 5% elastane. In black.

WAP7970XS-XXLOE



Women's Crest T-shirt

Sporty elegant T-shirt with deep, feminine round neckline for women. With rose-gold-colored Porsche Crest in a gloss print on the front. 95% cotton, 5% elastane. In white/rose gold color.

WAP8220XS-XXLOK



Women's Logo T-shirt

Sporty-elegant T-shirt with deep, feminine round neckline for women. With silver-colored 'PORSCHE' logo in a gloss print on the chest. 95% cotton, 5% elastane. In white/silver color.

WAP8250XS-XXLOK



Men's Turbo T-shirt

Sporty short-sleeved T-shirt for men with large 'turbo' 3D logo and small printed 'PORSCHE' logo on the chest. 50% cotton, 50% elastane. In mottled grey.

WAP82400S-3XL0K



Porsche Crest cap

100% cotton. With high-quality embroidered Porsche Crest. Adjustable size. In black.

WAP0800050C



Porsche Crest cap

100% cotton. With high-quality embroidered Porsche Crest. Adjustable size. In white.

WAP0800040C



Turbo baseball cap

Five-panel cap made of structured material with embossed 'turbo' logo. Metal clasp with 'PORSCHE' logo. Upper material: 97% polyester, 3% elastane. Lining: 100% cotton. In black.

WAP8200010K



Men's Turbo T-shirt

Sporty short-sleeved T-shirt for men with large 'turbo' 3D logo and small printed 'PORSCHE' logo on the chest. 100% cotton. In black.

WAP82300S-3XL0K



Men's Turbo hoodie

Hoodie embossed with large 'turbo' 3D logo and small printed 'PORSCHE' logo on the chest. With superimposed pocket and two side slits. Comfortable soft sweatshirt material. 72% polyester, 23% cotton, 5% elastane. In black.

WAP51800S-3XL0K



Men's bomber jacket

Modern bomber jacket with baseball collar, two side pockets and an inner pocket with a press stud. Elastic and ribbed cuffs. With 'PORSCHE' logo on the left chest and Porsche Crest [rubber badge] on the left upper arm. 100% polyester. In black.

WAP67600S-3XL0K



Men's polo shirt

Piqué polo shirt with embroidered 'PORSCHE' logo on the front. Cuffed. 100% cotton.

WAP75000S-3XLOB [black],
WAP75100S-3XLOB [white],
WAP90900S-3XLOB [red]



Women's polo shirt

Piqué polo shirt with embroidered 'PORSCHE' logo on the chest. Cuffs on sleeves. 96% cotton, 4% elastane. In black.

WAP7450XS-XXLOB



Baseball cap

100% polyester. Adjustable size. In black.

WAP0800020C



Hat and scarf set

Set consisting of a knitted hat and scarf with 'PORSCHE' label. 50% merino wool, 50% acrylic. Including gift packaging. In mottled dark grey.

WAP9400010K



Multifunction scarf

Seamless, versatile infinity scarf. With Porsche print and Crest label on the hem. Made from Coolmax fabric. 100% polyester. One-size-fits-all: 25 x 50cm.

WAP7270010MPOR



New

Men's denim jacket – Essential Collection

Denim jacket including four badges to sew on. Buttoned cuffs and adjustable side tabs. 'PORSCHE' logo on the left breast. 100% cotton. In blue.

WAP720XXXONPOR

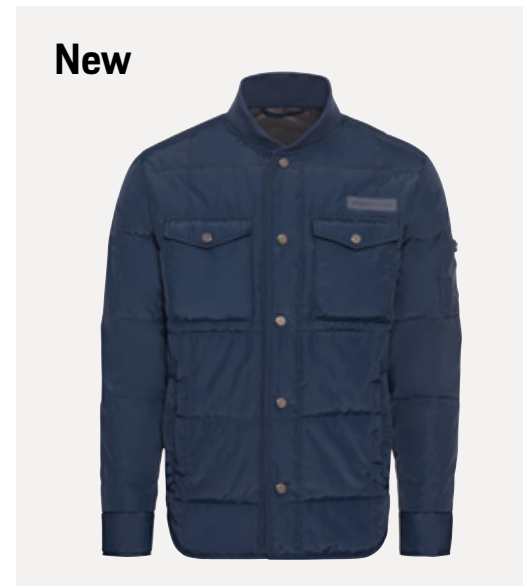

New

Men's quilted jacket – Essential Collection

Lightly padded shirt jacket with baseball collar. Including four badges to sew on. Press stud panel and breast pockets with buttoned flap. Slightly rounded hem. Long sleeves with slit and cuffs with press stud. 100% polyester. In blue.

WAP721XXXONPOR



New

Men's hoodie – Essential Collection

Men's hoodie. Porsche 911 sketch as flock print. Soft, comfortable sweat material. 65% cotton, 35% polyester. In red.

WAP722XXXONPOR

New



Men's T-shirt – Essential Collection

T-shirt with turned down short sleeves and crew neck. Porsche 911 sketch as flock print. 100% cotton. In white.

WAP723XXXONPOR 50



New



Women's quilted jacket – Essential Collection

Lightly padded shirt jacket with baseball collar. Including four badges to sew on. Press stud panel. Slightly rounded hem. 100% polyester. In khaki.

WAP724XXXONPOR

New



Women's hoodie – Essential Collection

Short hoodie with a casual fit. Golden Porsche Crest print. Made from soft material. 77% cotton, 19% polyester, 4% elastane. In black.

WAP725XXXONPOR

New



Women's T-shirt – Porsche Collection

Short sleeves with turned down sleeve hem and crew neck. Decorative Crest badge. 95% cotton, 5% elastane. In white.

WAP726XXXONPOR



Taycan Collection

100% electrifying, 100% Porsche – the collection for the first all-electric Porsche. Clear lines and smart details, urban looks and functional features combine everything that the new Taycan represents: intelligent technology, uncompromising design and electrifying enthusiasm in every respect. The tops, jackets and luggage bring tomorrow's style to city streets, featuring surprising, ground-breaking extras, such as the ultralight jacket with a decorative, fluorescent print, on which you can 'draw' individual illuminated styles.

Not only with the new Taycan does everyday life say goodbye to the 'mundane', the Taycan espresso and collector's mugs also set strong accents, as does the Taycan multi-purpose case. And the little Taycan wooden car is the perfect playmate for the next generation to embark upon their adventure into the future.



Men's polo shirt – Taycan

Short-sleeved polo shirt in functional piqué. Breathable and quick-drying. Laser-cut button placket with two buttons. Laser-cut collar. Decorative perforation on the collar, sleeve hem and back. With 'PORSCHE' logo on the chest and back. 100% polyester. In black/blue.

WAP60300S-3XL0LTYC



Women's polo shirt – Taycan

Short-sleeved polo shirt in functional piqué. Breathable and quick-drying. Laser-cut button placket with three buttons. Laser-cut collar. Decorative perforation on the collar, sleeve hem and back. With 'PORSCHE' logo on the chest and back. 100% polyester. In white/pink.

WAP6040XS-XXL0LTYC



Men's T-shirt – Taycan

Short-sleeved T-shirt with overcut, perforated shoulders. In functional jersey. Breathable and quick-drying. 'PORSCHE' logo on the chest and back. 92% polyester, 8% elastane. In blue.

WAP60100S-3XL0LTYC



Women's T-shirt – Taycan

Loose-cut T-shirt with perforated sleeves and wide cut-out. In functional jersey. Breathable and quick-drying. Further perforation on the back. Large, transparent glossy print with 'PORSCHE' logo on the front and additional 'PORSCHE' logo on the back. Laser-cut and bonded edges on neckline and sleeve hem. 92% polyester, 8% elastane. In pink.

WAP6020XS-XXL0LTYC





LE LIMITED EDITION



LE LIMITED EDITION

Unisex collector's T-shirt edition no. 16 – Limited Edition – Taycan

Collector's T-shirt inspired by the new Taycan, the first all-electric sports car with Porsche soul. Packaged in an exclusive metal box printed with the same motif. Includes a postcard explaining the vehicle. Very soft quality T-shirt. 100% cotton. In black/blue.

WAP6080XS-3XL0LTYC



Unisex ultralight jacket – Taycan

Lightweight, breathable, wind and water-repellent jacket with hood. With decorative, fluorescent all-over print inspired by the Porsche Taycan. The print glows in the dark if it has previously been irradiated with light. So individual light styles can be 'drawn' on the jacket. Upper-arm underside in mesh. Top of the body and hood lined with mesh. With two zipped side pockets. Elasticated sleeve hem. Elasticated hood. Light jacket quality. Outer fabric: 100% polyamide. Lining: 100% polyester. In white/blue.

WAP6070XS-3XL0LTYC



Men's jacket – Taycan

Padded jacket with hood. Water column 3,000mm [water pressure in millimetres that the outer material can withstand before letting in water] and breathability 3,000g/m²/24h [amount of evaporated liquid in grams per cubic metre in 24 hours]. Front, sleeves and hem on back in hard-shell material with fleece inner. Hood, shoulders, back and side panels in padded, contrasting woven chambers. With laser-cut zipped side pockets. Cuff-adjusters with concealed press studs. Decorative accents: reflective 'PORSCHE' logo on the chest and perforation on cuff-adjusters. 100% polyester. In black/blue.

WAP60500S-3XL0LTYC



Women's jacket – Taycan

Padded jacket with hood. Water column 3,000mm and breathability 3,000g/m²/24h. Front, sleeves and hem on back in hard-shell material with fleece inner. Hood, shoulders, back and side panels in padded, contrasting woven chambers. With laser-cut zipped side pockets. Cuff-adjusters with concealed press studs. Decorative accents: reflective 'PORSCHE' logo on the chest and perforation on cuff-adjusters. 100% polyester. In white/pink.

WAP6060XS-XXL0LTYC





Backpack – Taycan

Functional backpack in durable, wipeable outer materials. Front pocket with organiser and space for personal belongings. The main compartment with laptop and tablet compartment can be opened 180°. Highlight: integrated USB cable with port for connecting mobile devices. Padded back section with hidden zip compartment. Dimensions: approx. 36 × 21 × 47cm. Weight: approx. 1.3kg. 100% polyester. In black/grey/blue.

WAP0356000LTYC



Sports bag – Taycan

Functional sports bag in durable, wipeable outer materials. Side wet and shoe compartment with ventilation. Large front and back pocket with zip. Length-adjustable, detachable shoulder strap. Dimensions: approx. 65 × 40 × 30cm. Weight: approx. 1.5kg. 100% polyester in black/grey/blue.

WAP0606000LTYC



Multi-purpose case – Taycan

Functional case in polycarbonate with all-round zip. 'PORSCHE' logo on front and back. Inner compartments with zip pockets, mesh pockets and elasticated bands. Dimensions: approx. 18 × 13.5 × 7cm. In black/blue.

WAP0353040LMPC



Wooden car – Taycan

Wooden toy vehicle. Shape based on the Porsche Taycan. Length: approx. 12cm. 100% wood. For children aged two and above. Fits in the Porsche race truck. In natural/white/red/black. Made in Europe.

WAP0406000L



Urban Explorer Collection

'Either... or' is not an option in this collection. The Urban Explorer Collection has been developed to shape the future with the doers of tomorrow.

The collection is designed for the specific needs of business travellers. The high-quality clothing for men and women combines wearing comfort with a stylish look that guarantees a confident appearance, even after intercontinental flights.

The modern cuts captivate with functional details. Air intakes ensure optimum ventilation, hidden zip pockets provide space for cash and credit cards.

The combination of carefully selected materials, muted colors and ingenious design makes the Urban Explorer Collection the ideal companion on the way to your next challenge. Flexible, ambitious and ready to follow your own ideas into the future.



Women's sweatshirt – Urban Explorer

Sweatshirt with functional details. With two zipped side pockets and raised sideseam. Perforated shoulder yoke for optimum ventilation with zip. 'PORSCHE' logo on the chest. 68% polyester, 25% viscose, 7% elastane. In mottled grey/black.

WAP2130XS–XXL0LUEX



Women's polo shirt – Urban Explorer

Short-sleeved V-neck polo shirt with shirt collar and hidden side pocket. With 'PORSCHE' logo on the left upper arm. 95% cotton, 5% elastane. In khaki.

WAP2040XS–XXL0LUEX



Women's tracksuit bottoms – Urban Explorer

Comfortable tracksuit bottoms with drawstring, pleats and functional details such as perforated inserts on the backs of the knees for optimal ventilation. With two slip pockets, rear zip pocket and additional hidden zip pocket for valuables. With 'PORSCHE' logo on the left slip pocket. 68% polyester, 25% viscose, 7% elastane. In mottled grey.

WAP2100XS–XXL0LUEX



Men's quilted gilet – Urban Explorer

Lightly padded quilted gilet with press studs, two side pockets and V-neck. Ideal for travelling: the gilet can be packed up into a cushion. With 'PORSCHE' logo on the chest. Outer material: 71% nylon, 29% polyester. Lining: 100% nylon. Padding material: 100% polyester. In grey. Details in red.

WAP20700S–3XL0LUEX



Men's tracksuit bottoms – Urban Explorer

Comfortable tracksuit bottoms with functional details such as accentuated tucks and perforated inserts on the backs of the knees for optimal ventilation. With two slip pockets, rear zip pocket and additional, hidden zip pocket for valuables. Waistband with belt loops, button and zip. With 'PORSCHE' logo on the left slip pocket. 68% polyester, 25% viscose, 7% elastane. In black.

WAP21100S–3XL0LUEX



Men's T-shirt – Urban Explorer

Short-sleeved crew-neck T-shirt with attached chest pocket in front of zip pocket. 95% cotton, 5% elastane. In khaki.

WAP20200S–3XL0LUEX



Unisex Belt – Urban Explorer

Infinitely adjustable belt. Removable buckle embossed with 'PORSCHE' logo. Available in sizes S [80cm], M [95cm], L [110cm] and XL [125cm]. Belt: 100% polyester. Buckle: 96% zinc, 4% aluminium. In black.

WAP20000S–OXLOLUEX



2-in-1 travel bag and backpack – Urban Explorer

The functional design can be used as a bag or a backpack. Made of durable, water-repellent material. With wet compartment and separate laptop compartment. 100% polyester. In Anthracite with black and red details.

WAP0352010LUEX



Backpack – Urban Explorer

Backpack with roll-top made of durable, water-repellent material. With laptop compartment, hidden rear compartment and large main compartment. 100% polyester. In Anthracite with black and red details.

WAP0352000LUEX



Travel bag – Urban Explorer Collection

It's all in the bag: the large travel bag with spacious main compartment offers room for everything that is important on long road trips and short excursions. With an additional compartment for shoes and a detachable accessory pocket. 100% polyester. In Anthracite with black and red details.

WAP0352010NUEX





Glasses

You don't follow trends to become a style icon, you set them. Just like Porsche Design did in 1978 with its legendary aviator sunglasses featuring interchangeable lenses. The remake of this design classic is now available in the Porsche Driver's Selection shop, together with other selected sun and reading glasses from Porsche Design.

Not only the design of the exclusive eyewear is stylish, but also the performance: the high-quality plastic lenses in the sunglasses, for example, provide 100% UV protection, while high-performance materials ensure optimum stability that can effortlessly withstand all the challenges of a sporty lifestyle.



Reading glasses P '8801

The first Porsche among reading glasses – and still leading in design and function. The stainless steel frames: so consistently reduced to the essentials, that the form becomes timeless. The temples: the exciting contrast – dynamic in form, slightly transparent and made of high-tech polyamide. The lenses: scratch-resistant, unbreakable and with an extremely clear view. Frame: black. Temples: black.

WAP0788010L025 [2.5],
WAP0788010L020 [2.0],
WAP0788010L015 [1.5],
WAP0788010L010 [1.0]

Reading glasses P '8811

The exclusive Porsche Design reading glasses P '8811 combine sophisticated technology, perfect processing and exceptional design. The individuality and the style awareness of its wearer are reflected in the puristic and striking look of the P '8811. Stainless steel frame: black.

WAP0788110L025 [2.5],
WAP0788110L020 [2.0],
WAP0788110L015 [1.5],
WAP0788110L010 [1.0]





Sunglasses P '8508 – Heritage

Retro style, modern interpretation: stainless-steel aviators from Porsche Design with ultra flexible temples. In stainless steel. With 'Porsche Design' logo on the lens and temples. In gold color/Bordeaux Red. Made in Italy.

WAP0785080LHRT



Sunglasses P '8642 – 917 Salzburg

Modern, timeless sunglasses from Porsche Design in 917 Salzburg Collection look. In stainless steel. In red/white with 'Porsche Design' logo on the lens and temples. Lenses: silver mirrored. Made in Italy.

WAP0786420M917



Sunglasses P '8478 A

When they came out in 1978, the P '8478 sunglasses by Porsche Design were the world's first sunglasses with an interchangeable lens mechanism. Over six million pairs were sold. These true-to-the-original reproductions made of high-tech materials are also available from Porsche Driver's Selection. The exclusive Porsche Design sunglasses come with a set of interchangeable lenses. Titanium frame. Lenses made of polycarbonate with 100% UV protection. Frame: in light gold color. Lenses: in brown. Interchangeable lenses: in light blue/mirrored silver.

WAP0784780JA69



Sunglasses P '8478 B

When they came out in 1978, the P '8478 sunglasses by Porsche Design were the world's first sunglasses with an interchangeable lens mechanism. Over six million pairs were sold. These true-to-the-original reproductions made of high-tech materials are also available from Porsche Driver's Selection. The exclusive Porsche Design sunglasses come with a set of interchangeable lenses. Titanium frame. Lenses made of polycarbonate with 100% UV protection. Frame: titanium. Lenses: in mirrored gradient grey/silver. Interchangeable lenses: in green.

WAP0784780JB69



Sunglasses P '8642 M – MARTINI RACING®

Modern and timeless stainless steel design boasting the MARTINI RACING® look. The 3D effect of the straight-edge concept creates a fascinating lighting effect. In Dark Blue with 'MARTINI RACING®' print on the frame. Glasses mirrored blue. Made in Italy.

WAP0786420KM62





Sunglasses P'8508 A

Retro style, modern interpretation: the aviator glasses by Porsche Design are also available from Porsche Driver's Selection. The temples are ultra flexible. Model with polarised lenses. Stainless steel frame. Polycarbonate lenses with 100% UV protection. Frame: in gold color. Lenses: in Polarised Green.

WAP0785080JA62



Sunglasses P'8508 C

Retro design, stylishly reinterpreted. The Porsche Design aviator sunglasses are also available from Porsche Driver's Selection. With ultra-flexible arms. Stainless steel frame. Lenses made of polycarbonate with 100% UV protection. Frame: Palladium. Lenses: in olive/mirrored silver.

WAP0785080JC62



Sunglasses P'8565 A

Minimalist and sporty at the same time. The P'8565 sunglasses, the introductory model to the Porsche Design sunglasses collection, are also available from Porsche Driver's Selection. Their frame is particularly light and flexible. Stainless steel frame. Lenses made of polycarbonate with 100% UV protection. Frame: in black. Lenses: in green.

WAP0785650JA63



Sunglasses P'8565 D

Minimalist and sporty at the same time. The P'8565 sunglasses, the introductory model to the Porsche Design sunglasses collection, are also available from Porsche Driver's Selection. Their frame is particularly light and flexible. Stainless steel frame. Lenses made of polycarbonate with 100% UV protection. Frame: in Titanium. Lenses: in grey blue.

WAP0785650JD63



Watches

Over 70 years of Porsche Motorsport experience have made one thing very clear: when one second can be the difference between victory and defeat, uncompromising precision is everything. A standard that is set by Porsche even off the race track. For example, in the watches of the Porsche Driver's Selection.

As an unusual Limited Edition or extremely versatile version thanks to an interchangeable strap. Uncompromisingly sporty or puristic and elegant. The combination of cutting-edge technology, high-quality materials and timeless design turns the watches from Porsche Driver's Selection into exclusive lifestyle products that match the purest of sports car enthusiasm.

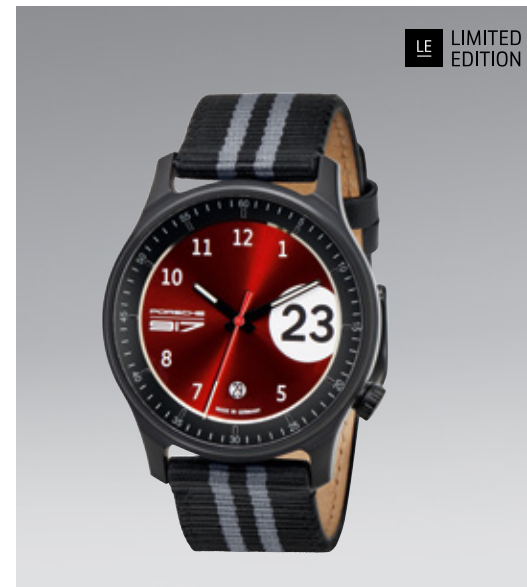

Pure Watch – Limited Edition – 917 Salzburg

Limited to 1,917 units. Three-hand watch with Swiss parts movement. Waterproof up to 5ATM. Stainless steel with black PVD coating. Mineral glass with anti-glare coating on one side. Red metal dial with the familiar white racing 'lollipop' and black start number 23. Porsche 917 logo at 9 o'clock, date display at 6 o'clock. Black/Anthracite fabric strap. PVD-coated stainless steel clasp with engraved 'PORSCHE' logo. Strap assembly with two spring pins. Design by Studio F. A. Porsche. With high-quality watch packaging. Diameter: 42mm. Made in Germany.

WAP0700030M917



Pure Watch

Swiss Ronda movement with one jewel. Satin-finished case, waterproof up to 5ATM. Includes engraving on base with serial number. Curved mineral glass with sapphire coating on one side. Case, crown and tube are made of toughened stainless steel featuring bi-O'Ring system. Press-fit base. Strap assembly with two stainless steel spring pins. Hour and minute hands in black with white Super-LumiNova. Matt black dial. Black leather strap with Guards Red stitching. Pin clasp made of stainless steel with a fine satin finish. High-quality gift packaging. Diameter: 42mm.

WAP0700100L0PW



Porsche Carbon Composite Chronograph

Lightweight sports chronograph with a carbon composite case. Swiss Ronda movement with 13 jewels. Waterproof up to 5ATM. Scratch-resistant glass with sapphire coating on one side. Hour and minute hands as well as indices with white Super-LumiNova. Three totalisators. Integrated stop function. Rubber strap with honeycomb structure on the top and tyre markings embossed on the underside. Satin-finished stainless steel pin clasp with engraved 'PORSCHE' logo. Strap assembly with two stainless steel spring pins. Design by Studio F. A. Porsche. In high-quality gift packaging. Diameter: 42mm.

WAP0700050MCRB



CH SWISS MADE

Classic chronograph – Turbo

Classic chronograph with RONDA movement and four jewels. Silver-colored metal dial with details in blue and red, plus the 'turbo' logo. Sapphire crystal with anti-reflection coating on one side. Stainless steel case with a fine satin finish. Waterproof up to 10ATM. Tube and crown screwed and polished. Night Blue fabric strap with length adjustment. Strap width: 22mm. Stainless steel clasp with engraved 'PORSCHE' logo. Design by Studio F. A. Porsche. With high-quality watch packaging. Height: 12mm. Diameter: 44mm. Swiss made.

WAP0700880LCLC



CH SWISS MADE

Unisex Sport Chrono – 911

Chronograph design inspired by the new [8th] generation of the 911. Swiss RONDA movement with 13 jewels. Two-part stainless steel case with Dark Silver PVD coating. Waterproof up to 10ATM. Metal dial with the Porsche Crest at 12 o'clock. Sapphire glass with anti-reflection coating on one side. Rubber strap in black with honeycomb structure on the top and tyre markings embossed on the underside. Stainless steel pin buckle with Dark Silver PVD coating and engraved 'PORSCHE' logo. Diameter: 38mm. Swiss made.

WAP0709000K



CH SWISS MADE

Sport Chrono – MARTINI RACING®

Chronograph featuring a MARTINI RACING® design. Swiss ETA movement with four jewels. With PowerDrive to increase the speed with which the hands move to more than 200Hz. Three-part stainless steel casing. Waterproof up to 10ATM. Milled grooves with separately inlaid design elements in black. Metal dial with MARTINI RACING® stripes. Sapphire glass with anti-reflection treatment on one side. Rubber strap in black with honeycomb structure on the top and tyre relief on the bottom. Stainless steel pin clasp with lasered 'PORSCHE' logo. Diameter: 42mm. Swiss made.

WAP0700020J



CH SWISS MADE

Chronograph – MARTINI RACING®

Chronograph in MARTINI RACING® design. Swiss ETA movement with four stones. Black, metal dial face with the typical 'MARTINI RACING® PORSCHE' logo and stripes. Super-LumiNova on the hour and minute hands and numbers. Five-part, stainless steel case, finely satined. Waterproof up to 10ATM. Integrated stop function. Sapphire crystal with one-sided anti-reflective coating tube and crown screwed down and polished, with engraved Porsche Crest on the front surfaces. Metal strap with length regulating elements. Strap width: 22mm. Stainless steel pin clasp with engraved 'PORSCHE' logo. With high-value watch packaging. Height: 12mm. Diameter: 42mm. Swiss made.

WAP0700710LMRC

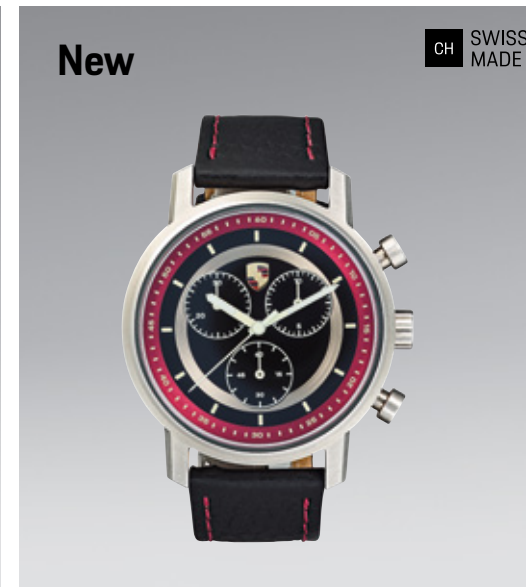

New

CH SWISS MADE

Chronograph 718 RS 60 Spyder

Chronograph inspired by the legendary Porsche 718 RS 60 Spyder. Swiss RONDA movement with four jewels. Black metal dial with silver-colored rings and Burgundy Red and off-white details based on the interior equipment of the historic race car. Super-LumiNova on the hour and minute hands and indices. Integrated stop function. Three totalisators. Black leather strap with red stitching, analogous to the color of the vehicle seats. Stainless steel clasp with engraved 'PORSCHE' logo. With high-quality watch packaging. Diameter: 44mm. Swiss made.

WAP0700020M718

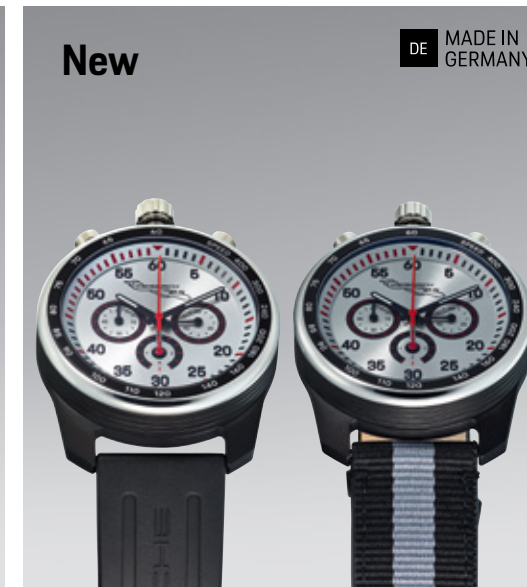

New

DE MADE IN GERMANY

Chronograph Race

Miyota OS30 movement. Super-LumiNova on the hour and minute hands. Integrated stop function. Stainless steel clasp with engraved 'PORSCHE' logo. With high-quality watch packaging. Diameter: 42mm. Made in Germany.

WAP0700090NRAC



Luggage

Porsche sports cars are known for their extraordinary performance, unmistakable design and exclusive equipment. But above all, it is their intelligent overall concept that makes them stand out. The luggage from Porsche Driver's Selection extends this concept to the luggage compartment: to match the latest fashion collections in the form of extremely high-quality leisure bags, nostalgic classics or sports equipment.

The luggage ranges from Porsche Driver's Selection combine modern, robust materials with practical interior compartments and an uncompromisingly sporty look. Whether in the form of an extremely functional 2-in-1 version that can be used both as a backpack and a travel bag, as an elegant weekender with leather trim or featuring the stylish MARTINI RACING® look – every item encourages wanderlust. Because one thing is clear: Porsche fans simply have no intention of standing still.

For volume options showing how many items of luggage fit into which Porsche model, please refer to page 320.



PTS Multiwheel® Ultralight Edition 2.0 M

Robust, ultralight Multiwheel® suitcase in polycarbonate. The case shells react flexibly under pressure and give way. Dimensions adapted to the storage spaces of Porsche sports cars, suitable for all model series. Special aluminium handle for easier loading into the luggage compartments. Recessed TSA lock, infinitely adjustable telescopic handle and mesh zip pockets inside. Lining with woven PORSCHE logo. TÜV tested. Five-year guarantee. Volume: approx. 33l. Weight: approx. 3.2kg. Dimensions: approx. 55 × 40 × 20cm. In Agate Grey

WAP0354010LM7S

PTS Multiwheel® Ultralight Edition 2.0 M

Robust, ultralight Multiwheel® suitcase in polycarbonate. The case shells react flexibly under pressure and give way. Dimensions adapted to the storage spaces of Porsche sports cars, suitable for all model series. Special aluminium handle for easier loading into the luggage compartments. Recessed TSA lock, infinitely adjustable telescopic handle and mesh zip pockets inside. Lining with woven PORSCHE logo. TÜV tested. Five-year guarantee. Volume: approx. 33l. Weight: approx. 3.2kg. Dimensions: approx. 55 × 40 × 20cm. In Carrara White.

WAP0354010LB9A

PTS Multiwheel® Ultralight Edition 2.0 M

Robust, ultralight Multiwheel® suitcase in polycarbonate. The case shells react flexibly under pressure and give way. Dimensions adapted to the storage spaces of Porsche sports cars, suitable for all model series. Special aluminium handle for easier loading into the luggage compartments. Recessed TSA lock, infinitely adjustable telescopic handle and mesh zip pockets inside. Lining with woven PORSCHE logo. TÜV tested. Five-year guarantee. Volume: approx. 33l. Weight: approx. 3.2kg. Dimensions: approx. 55 × 40 × 20cm. In GT Silver.

WAP0354010LM7Z

PTS Multiwheel® Ultralight Edition 2.0 M

Robust, ultralight Multiwheel® suitcase in polycarbonate. The case shells react flexibly under pressure and give way. Dimensions adapted to the storage spaces of Porsche sports cars, suitable for all model series. Special aluminium handle for easier loading into the luggage compartments. Recessed TSA lock, infinitely adjustable telescopic handle and mesh zip pockets inside. Lining with woven PORSCHE logo. TÜV tested. Five-year guarantee. Volume: approx. 33l. Weight: approx. 3.2kg. Dimensions: approx. 55 × 40 × 20cm. In matt black.

WAP0354010LR01

PTS Multiwheel® Ultralight Edition 2.0 M

Robust, ultralight Multiwheel® suitcase in polycarbonate. The case shells react flexibly under pressure and give way. Dimensions adapted to the storage spaces of Porsche sports cars, suitable for all model series. Special aluminium handle for easier loading into the luggage compartments. Recessed TSA lock, infinitely adjustable telescopic handle and mesh zip pockets inside. Lining with woven PORSCHE logo. TÜV tested. Five-year guarantee. Volume: approx. 33l. Weight: approx. 3.2kg. Dimensions: approx. 55 × 40 × 20cm. In Guards Red.

WAP0354010L84A



PTS Multiwheel® Ultralight Edition 2.0 XL

Robust, ultralight Multiwheel® suitcase in polycarbonate. The case shells react flexibly under pressure and give way. Dimensions adapted to the storage spaces of Porsche sports cars, suitable for all model series. Special aluminium handle for easier loading into the luggage compartments. Recessed TSA lock, infinitely adjustable telescopic handle and mesh zip pockets inside. Lining with woven PORSCHE logo. TÜV tested. Five-year guarantee. Volume: approx. 74l. Weight: approx. 4.6kg. Dimensions: approx. 60.5 × 38.5 × 40cm. In Agate Grey.

WAP0354000LM7S



PTS Multiwheel® Ultralight Edition 2.0 XL

Robust, ultralight Multiwheel® suitcase in polycarbonate. The case shells react flexibly under pressure and give way. Dimensions adapted to the storage spaces of Porsche sports cars, suitable for all model series. Special aluminium handle for easier loading into the luggage compartments. Recessed TSA lock, infinitely adjustable telescopic handle and mesh zip pockets inside. Lining with woven PORSCHE logo. TÜV tested. Five-year guarantee. Volume: approx. 74l. Weight: approx. 4.6kg. Dimensions: approx. 60.5 × 38.5 × 40cm. In Carrara White.

WAP0354000LB9A



PTS Multiwheel® Ultralight Edition 2.0 XL

Robust, ultralight Multiwheel® suitcase in polycarbonate. The case shells react flexibly under pressure and give way. Dimensions adapted to the storage spaces of Porsche sports cars, suitable for all model series. Special aluminium handle for easier loading into the luggage compartments. Recessed TSA lock, infinitely adjustable telescopic handle and mesh zip pockets inside. Lining with woven PORSCHE logo. TÜV tested. Five-year guarantee. Volume: approx. 74l. Weight: approx. 4.6kg. Dimensions: approx. 60.5 × 38.5 × 40cm. In GT Silver.

WAP0354000LM7Z



PTS Multiwheel® Ultralight Edition 2.0 XL

Robust, ultralight Multiwheel® suitcase in polycarbonate. The case shells react flexibly under pressure and give way. Dimensions adapted to the storage spaces of Porsche sports cars, suitable for all model series. Special aluminium handle for easier loading into the luggage compartments. Recessed TSA lock, infinitely adjustable telescopic handle and mesh zip pockets inside. Lining with woven PORSCHE logo. TÜV tested. Five-year guarantee. Volume: approx. 74l. Weight: approx. 4.6kg. Dimensions: approx. 60.5 × 38.5 × 40cm. In matt black.

WAP0354000LR01



PTS Multiwheel® Ultralight Edition 2.0 XL

Robust, ultralight Multiwheel® suitcase in polycarbonate. The case shells react flexibly under pressure and give way. Dimensions adapted to the storage spaces of Porsche sports cars, suitable for all model series. Special aluminium handle for easier loading into the luggage compartments. Recessed TSA lock, infinitely adjustable telescopic handle and mesh zip pockets inside. Lining with woven PORSCHE logo. TÜV tested. Five-year guarantee. Volume: approx. 74l. Weight: approx. 4.6kg. Dimensions: approx. 60.5 × 38.5 × 40cm. In Guards Red.

WAP0354000L84A





PTS Multiwheel® Ultralight Edition 2.0 XXL

Robust, ultralight Multiwheel® suitcase in polycarbonate. The case shells react flexibly under pressure and give way. Dimensions adapted to the storage spaces of Porsche sports cars, suitable for all model series. Special aluminium handle for easier loading into the luggage compartments. Recessed TSA lock, infinitely adjustable telescopic handle and mesh zip pockets inside. Lining with woven PORSCHE logo. TÜV tested. Five-year guarantee. Volume: approx. 80l. Weight: approx. 5.1kg. Dimensions: approx. 74 × 49 × 27.5cm. In Agate Grey.

WAP0354020LM7S



PTS Multiwheel® Ultralight Edition 2.0 XXL

Robust, ultralight Multiwheel® suitcase in polycarbonate. The case shells react flexibly under pressure and give way. Dimensions adapted to the storage spaces of Porsche sports cars, suitable for all model series. Special aluminium handle for easier loading into the luggage compartments. Recessed TSA lock, infinitely adjustable telescopic handle and mesh zip pockets inside. Lining with woven PORSCHE logo. TÜV tested. Five-year guarantee. Volume: approx. 80l. Weight: approx. 5.1kg. Dimensions: approx. 74 × 49 × 27.5cm. In matt black.

WAP0354020LR01



PTS Multiwheel® Ultralight Edition 2.0 XXL

Robust, ultralight Multiwheel® suitcase in polycarbonate. The case shells react flexibly under pressure and give way. Dimensions adapted to the storage spaces of Porsche sports cars, suitable for all model series. Special aluminium handle for easier loading into the luggage compartments. Recessed TSA lock, infinitely adjustable telescopic handle and mesh zip pockets inside. Lining with woven PORSCHE logo. TÜV tested. Five-year guarantee. Volume: approx. 80l. Weight: approx. 5.1kg. Dimensions: approx. 74 × 49 × 27.5cm. In Guards Red.

WAP0354020L84A





Active backpack

Waterproof backpack with large main compartment, roll-top and zip. Small separate front compartment with zip [not waterproof]. Side pockets, inside with compartment for laptop and additional slip-in compartment. Volume: 24l.

WAP0350040MACB



Weekender – Heritage

Modern canvas weekender bag inspired by the Porsche 911 Targa 4S Heritage Design Edition. Porsche logo and other accents in gold color. High-quality leather straps and adjustable shoulder strap. Inside zip compartment. Including three separate inner pockets for shoes, shirts and accessories. 35% linen, 40% cotton, 25% cowhide leather. In Anthracite. Made in Italy.

WAP0350110LHRT

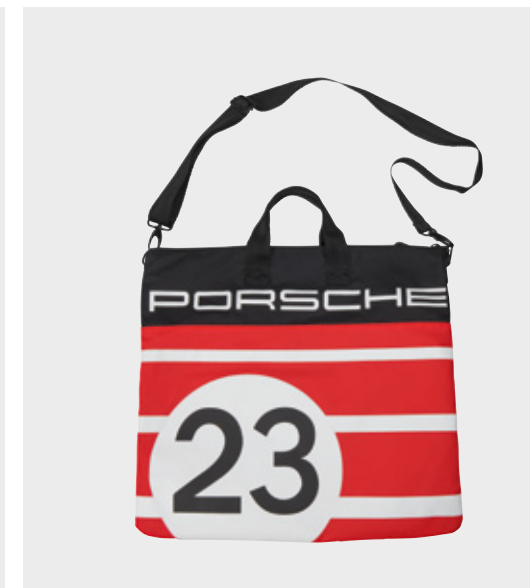

Bag – 917 Salzburg

Sporty bag with print design inspired by the Porsche 917 Salzburg which offers plenty of space for a helmet. Helmet bags were designed to protect helmets from scratches, and went hand in hand with the development of hard shell helmets in the 1950s. A carabiner was used to hang the bag so that it stayed open, allowing the helmet to be ventilated. With two patch pockets and an inner pocket with zip. With detachable shoulder strap and handles. Water-repellent. Durable nylon material: 100% polyamide. Dimensions: approx. 46 × 48cm. Unisex. In red/white/black.

WAP0354600MSZG

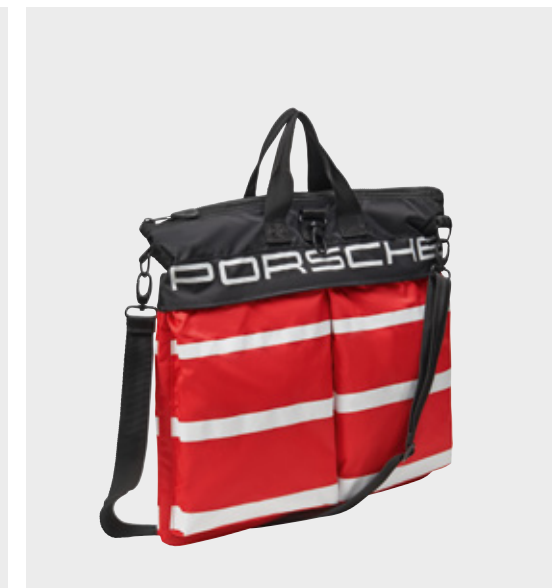



Sports bag – Taycan

Functional sports bag in durable, wipeable outer materials. Side wet and shoe compartment with ventilation. Large front and back pocket with zip. Length-adjustable, detachable shoulder strap. Dimensions: approx. 65 × 40 × 30cm. Weight: approx. 1.5kg. 100% polyester in black/grey/blue.

WAP0606000LTYC



Backpack – Taycan

Functional backpack in durable, wipeable outer materials. Front pocket with organiser and space for personal belongings. The main compartment with laptop and tablet compartment can be opened 180°. Highlight: integrated USB cable with port for connecting mobile devices. Padded back section with hidden zip compartment. Dimensions: approx. 36 × 21 × 47cm. Weight: approx. 1.3kg. 100% polyester. In black/grey/blue.

WAP0356000LTYC



Multi-purpose case – Taycan

Very functional case in polycarbonate with all-round zip. 'PORSCHE' logo on front and back. Inner compartments with zip pockets, mesh pockets and elasticated bands. Dimensions: approx. 18 × 13.5 × 7cm. In black/blue.

WAP0353040LMPC



2-in-1 travel bag and backpack – Urban Explorer

The functional design can be used as a bag or a backpack. Made of durable, water-repellent material. With wet compartment and separate laptop compartment. 100% polyester. In Anthracite with black and red details.

WAP0352010LUEX



Backpack – Urban Explorer

Backpack with roll-top made of durable, water-repellent material. With laptop compartment, hidden rear compartment and large main compartment. 100% polyester. In Anthracite with black and red details.

WAP0352000LUEX



Travel bag – Urban Explorer Collection

It's all in the bag: the large travel bag with spacious main compartment offers room for everything that is important on long road trips and short excursions. With an additional compartment for shoes and a detachable accessory pocket. 100% polyester. In anthracite with black and red details.

WAP0352010NUEX



2-in-1 messenger bag and backpack

2-in-1 bag in a durable, functional material. Stowable carry strap. Can be used as a shoulder bag or a backpack. With padded compartment for a tablet or laptop. With multiple inside pockets for smartphones, pens, business cards and cables. With trolley link. Size: approx. 32 × 13 × 46cm. Volume: approx. 23l. Weight: approx. 1.5kg. 100% polyester. In black.

WAP0359450K



Laptop sleeve

Functional and durable neoprene laptop sleeve with embossed 'PORSCHE' logo on the front inner pocket for pens. For devices up to 13 inches. Made of neoprene. In black.

WAP0300110K



Backpack – Motorsport Fanwear

Backpack with laptop slide-in compartment. Front compartment with zip pockets and spacious mesh pockets on the sides. Padding on the straps and back. With 'PORSCHE MOTORSPORT' signet. 100% polyester. In black.

WAP0350030LFMS



Pull bag – Motorsport Fanwear

Lightweight backpack in classic gym bag design with drawstring shoulder strap. With exterior zip pocket and 'PORSCHE MOTORSPORT' signet. 100% polyester. In black.

WAP0350010LFMS



2 in 1 Messenger Bag & Rucksack – Essential Collection

Practical 2-in-1 bag that can be worn as a bag or backpack. Made from recycled material, from 16 plastic bottles. Durable, easy-care material. With Porsche logo on the front. Main compartment with organiser, e.g. for smartphone and keys, and padded compartment for tablet or laptop. In black.

WAP0359450NSCH



Backpack, black – Essential Collection

Practical backpack made from recycled material, from 15 plastic bottles. Durable, easy-care material. With Porsche logo on the front. Main compartment with organiser, e.g. for smartphone and keys, and padded compartment for tablet or laptop. In black.

WAP0350080NSCH



Cool bag – MARTINI RACING®

Spacious, waterproof cool bag with badges in MARTINI RACING® design. An additional compartment on the front can be closed with a zip; the length of the removable shoulder strap can be adjusted. In dark blue/light blue/white.

WAP0359290MOMR



Backpack – MARTINI RACING®

A modern backpack in the popular MARTINI RACING® design with a 3D logo on the front and green details. Spacious internal compartment with laptop compartment. Separate front pocket and hidden back pocket. With trolley link. Outer material: 70% polyester, 30% acrylic. Lining: 100% polyester. In dark blue.

WAP0359260LOMR



Leisure bag – MARTINI RACING®

A modern sports bag in the popular MARTINI RACING® design with a 3D logo on the front and green details. Spacious main compartment with small inner pocket with zip for personal belongings. Two side pockets. With detachable shoulder strap. Outer material: 70% polyester, 30% acrylic. Lining: 100% polyester. In dark blue.

WAP0359270LOMR

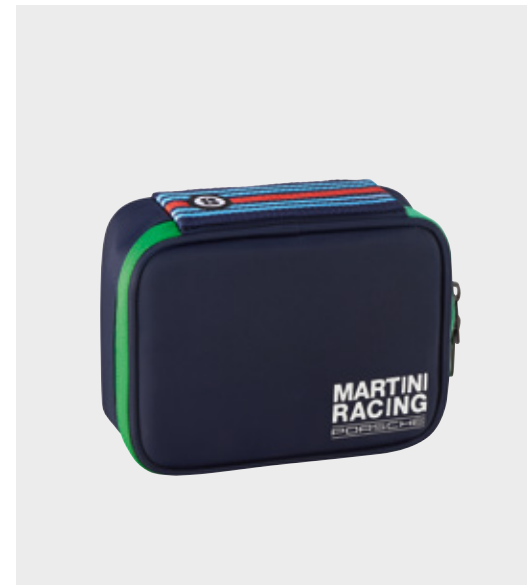

Multipurpose case – MARTINI RACING®

Soft case in the beloved MARTINI RACING® design with green details. With diverse interior compartments for safe storage of belongings, such as headphones, a power bank or charging cables. 60% polyester, 40% nylon. In dark blue.

WAP0359280LOMR



Porsche Pet's Collection

Modern materials and intelligent design provide maximum comfort and optimum suitability for everyday use – as expected from Porsche. But the sportiness of this collection on the road depends on the thirst for adventure of your four-legged friend.

The Porsche Pet's Collection is the first collection for pets with Porsche DNA, for a touch of extra enthusiasm on the daily walk.

The exclusive dog accessories are made from a modern material, which is not only robust and reliable but also especially lightweight. The lead and collar offer security when it's needed, but are still comfortable for the animal to wear.

The high-quality clip on the collar is made from a die-cast zinc alloy, embossed with the 'PORSCHE' logo. The lead features the signature on a small metal plaque. Both products are available in S, M and L.



Dog collar – Porsche Pets

Dog collar made from robust material [100% polyester]. Embossed with the 'PORSCHE' logo on the buckle made of 100% zinc alloy. Available in three sizes. In grey.

WAP0306000K001 [S | 20 × 350 mm],
WAP0306000K002 [M | 25 × 500 mm],
WAP0306000K003 [L | 32 × 650 mm]



Dog lead – Porsche Pets

Functional dog lead made from robust material [100% polyester]. With embossed 'PORSCHE' logo on the metal plate. Metal elements made of 100% zinc alloy. Available in three sizes. In grey.

WAP0306010K001 [S | 20 × 2.000 mm],
WAP0306010K002 [M | 25 × 2.000 mm],
WAP0306010K003 [L | 32 × 2.000 mm]





Porsche Originals

Whether it's the first edition of a work of world literature or a painting from a modern master – we are particularly drawn to originals. Porsche Originals are no exception.

With the fine lifestyle accessories, the ideas of Porsche engineers and designers find their way into the offices and living rooms of discerning sports car enthusiasts. Because the Porsche Originals are original vehicle parts that have been intelligently repurposed to add a dose of sports cars to every day life.

New

DE MADE IN GERMANY
P PORSCHE ORIGINAL
LE LIMITED EDITION



911 Turbo S: fuel consumption [in l/100km] urban 15.5 · extra urban 8.6 · combined 11.1 [NEDC]; combined 12.3–12.0 [WLTP]; CO₂ emissions [in g/km] combined: 254 [NEDC]; 278–271 [WLTP]

911 sculpture – Bespoke Edition

Limited, personalisable and three-dimensional wall installation, consisting of an original body part of the 911 Turbo [992]. Silhouette of the 911 Turbo [992] with high-quality film over the entire rear wall. Side panel made of aluminium, painted with one of the 17 Porsche exterior colors. Five-part aluminium back panel, painted matt black or matt white, each framed in silver anodised aluminium. Limited to 99 units worldwide. With Limited Edition plaque. Dimensions: approx. 4,800 × 1,480 × 550mm. Weight approx. 45kg. Made in Germany.

WAP0501150N001 [white/black]

WAP0501150N002 [black/black]

WAP0501150N003 [Guards Red/black]

WAP0501150N004 [Racing Yellow/black]

WAP0501150N005 [Carrara White Metallic/black]

WAP0501150N006 [Jet Black Metallic/black]

WAP0501150N007 [Agate Grey Metallic/black]

WAP0501150N008 [Dolomite Silver Metallic/black]

WAP0501150N009 [GT Silver Metallic/black]

WAP0501150N010 [Gentian Blue Metallic/black]

WAP0501150N011 [Night Blue Metallic/black]

WAP0501150N012 [Aventurine Green Metallic/black]

WAP0501150N013 [Crayon/black]

WAP0501150N014 [Carmine Red/black]

WAP0501150N015 [Lava Orange/black]

WAP0501150N016 [Shark Blue/black]

WAP0501150N017 [Python Green/black]

WAP0501150N018 [white/white]

WAP0501150N019 [black/white]

WAP0501150N020 [Guards Red/white]

WAP0501150N021 [Racing Yellow/white]

WAP0501150N022 [Carrara White Metallic/white]

WAP0501150N023 [Jet Black Metallic/white]

WAP0501150N024 [Agate Grey Metallic/white]

WAP0501150N025 [Dolomite Silver Metallic/white]

WAP0501150N026 [GT Silver Metallic/white]

WAP0501150N027 [Gentian Blue Metallic/white]

WAP0501150N028 [Night Blue Metallic/white]

WAP0501150N029 [Aventurine Green Metallic/white]

WAP0501150N030 [Crayon/white]

WAP0501150N031 [Carmine Red/white]

WAP0501150N032 [Lava Orange/white]

WAP0501150N033 [Shark Blue/white]

WAP0501150N034 [Python Green/white]

New

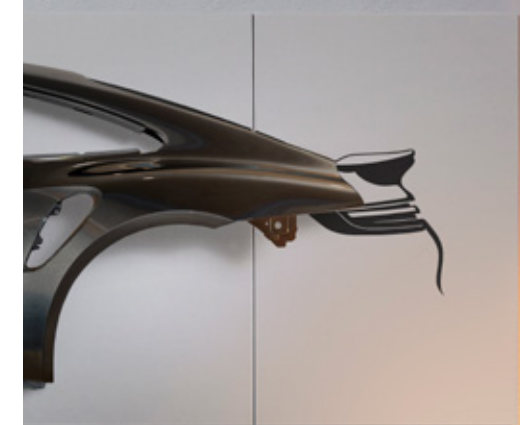



911 Motorsport bonnet

Original bonnet of the historic Porsche 911 [G Series] with original historic Porsche Crest. White with high-quality decoration, inspired by popular motorsport paint finishes. Magnetic. Includes hanging device and drilling template to mount on the wall. Dimensions: approx. 120 × 130cm. Weight: approx. 15kg. Made to order.

WAP050300MSFG



911 Salzburg bonnet

Original bonnet of the historic Porsche 911 [G Series] with original historic Porsche Crest. Red with high-quality decoration in the style of the legendary 917 Salzburg livery. Magnetic. Includes hanging device and drilling template to mount on the wall. Dimensions: approx. 120 × 130cm. Weight: approx. 15kg. Made to order.

WAP0503010MSFB



911 Exclusive Manufaktur bonnet

Original bonnet of the historic Porsche 911 [G Series] with original historic Porsche Crest. Golden Yellow Metallic with high-quality stripe decoration in black. Magnetic. Includes hanging device and drilling template to mount on the wall. Dimensions: approx. 120 × 130cm. Weight: approx. 15kg. Made to order.

WAP0503050MEXC

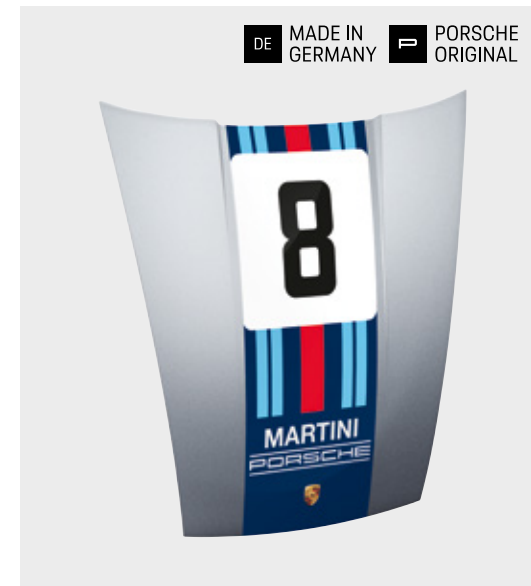

911 MARTINI RACING® Lollipop bonnet

Original bonnet of the historic Porsche 911 [G Series] with original historic Porsche Crest. Bonnet painted in Silver Metallic with high-quality MARTINI RACING® trim and start number 8. Magnetic. Includes hanging device and drilling template to mount on the wall. Dimensions: approx. 120 × 130cm. Weight: approx. 15kg. Made to order.

WAP0503020MMR1

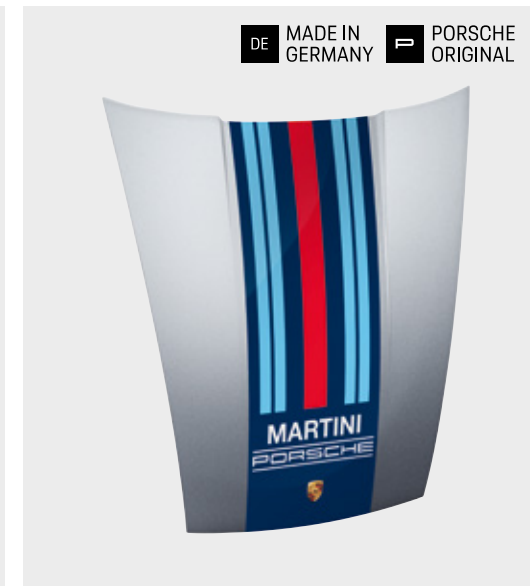

911 MARTINI RACING® bonnet

Original bonnet of the historic Porsche 911 [G Series] with original historic Porsche Crest. Bonnet painted in Silver Metallic with high-quality MARTINI RACING® trim. Magnetic. Includes hanging device and drilling template to mount on the wall. Dimensions: approx. 120 × 130cm. Weight: approx. 15kg. Made to order.

WAP0503030MMR2



DE MADE IN GERMANY
P PORSCHE ORIGINAL

Porsche classic cooler

Made from an original Porsche cylinder with cooling fins from the early air-cooled 911 models [G models]. Made of aluminium. Made in Germany.

WAP0500600C

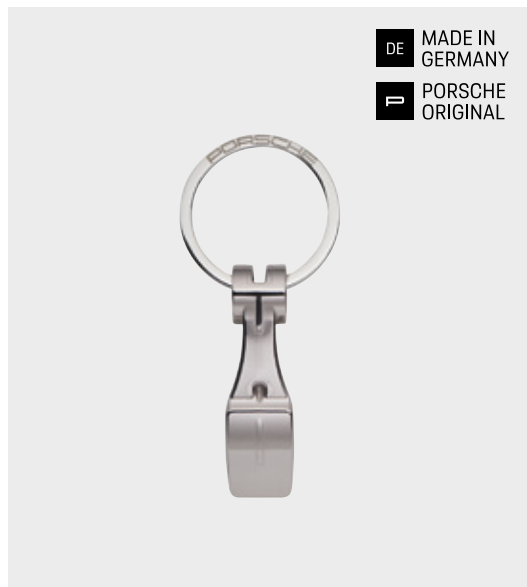

DE MADE IN GERMANY
P PORSCHE ORIGINAL

Cam follower key ring – 911 GT3

Key ring made from an original GT3 cam follower. In polished silver color with Porsche engraving on the key ring.

WAP0500100MGT3

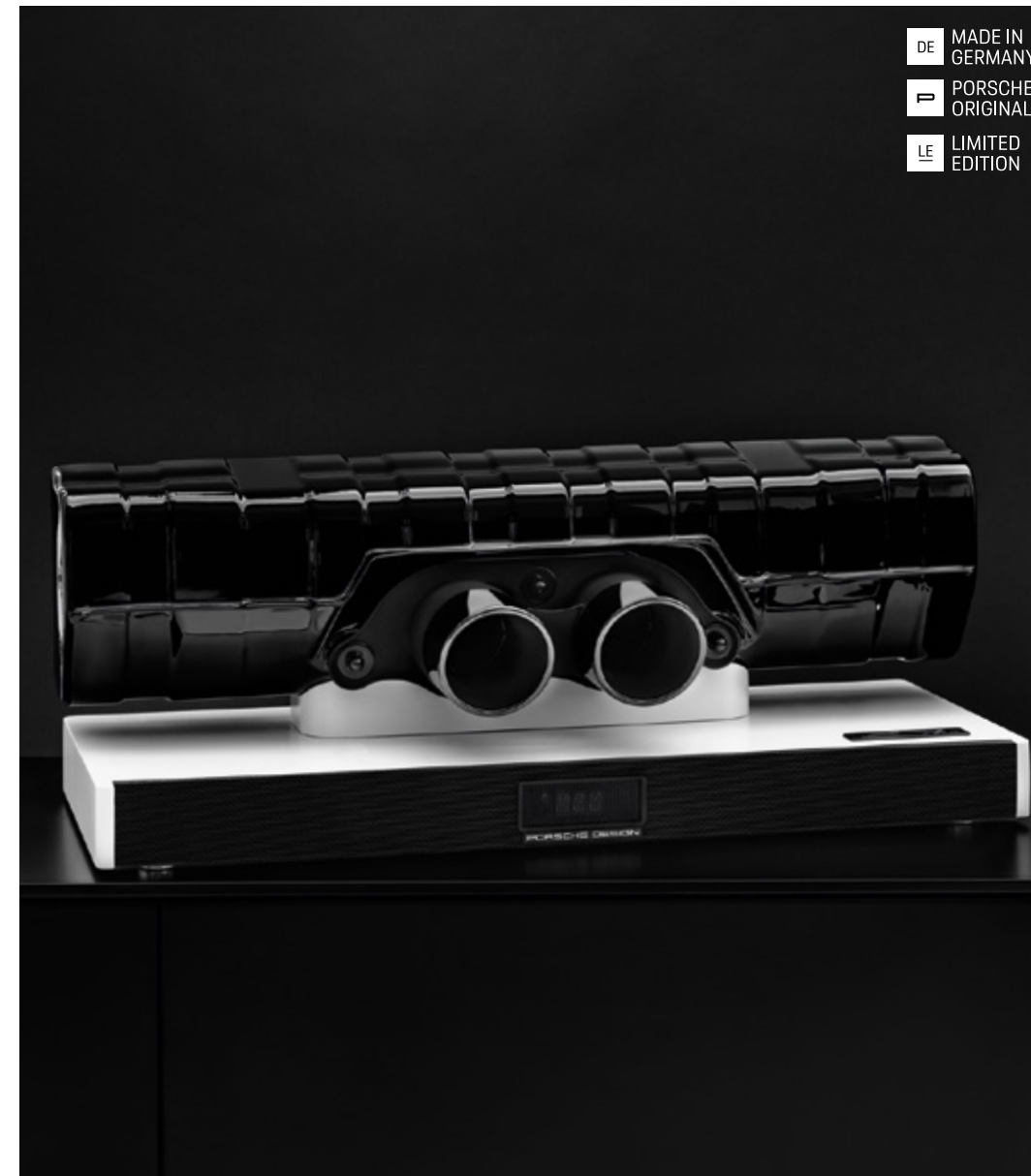

DE MADE IN GERMANY
P PORSCHE ORIGINAL
LE LIMITED EDITION

911 Soundbar Special Edition – Limited Edition

The 911 Soundbar Special Edition: a high-end 2.1 virtual surround sound system with Dolby Atmos® decoder and the original exhaust system of the Porsche 911 GT3 as a subwoofer extension. 300-watt system power. With LED display and OSD [on-screen display]. WiFi compatible. Chromecast built-in™ for multi-room system and a variety of premium streaming services such as Spotify®. Compatible with GOOGLE® Android and iOS. Including infrared remote control. Limited to 500 units. In white/black. Made in Germany. Porsche Original.

WAP0501110LSPE



Wheel rim wall clock

Wall clock made from an original rim in the RS Spyder Design of the current Porsche 911. Super-LumiNova hands glow in the dark. Elegant element with 'PORSCHE' logo. Includes wall mount. Weight: approx. 8.7kg.

WAP0700110L



911 Carrera 4S: fuel consumption in l/100km: urban 14.8–13.1 · extra urban 7.8–7.4 · combined 10.1–9.7 [NEDC]; combined 11.1–10.2 [WLTP]; CO₂ emissions in g/km combined: 231–222 [NEDC]; 253–231 [WLTP]

DE MADE IN GERMANY
P PORSCHE ORIGINAL



Bookend

Made from an original Porsche 911 Carrera brake disc. Mounted on a steel bracket coated in black. With rubber feet. Fully reversible. Made in Germany.

WAP0500020F

DE MADE IN GERMANY
P PORSCHE ORIGINAL

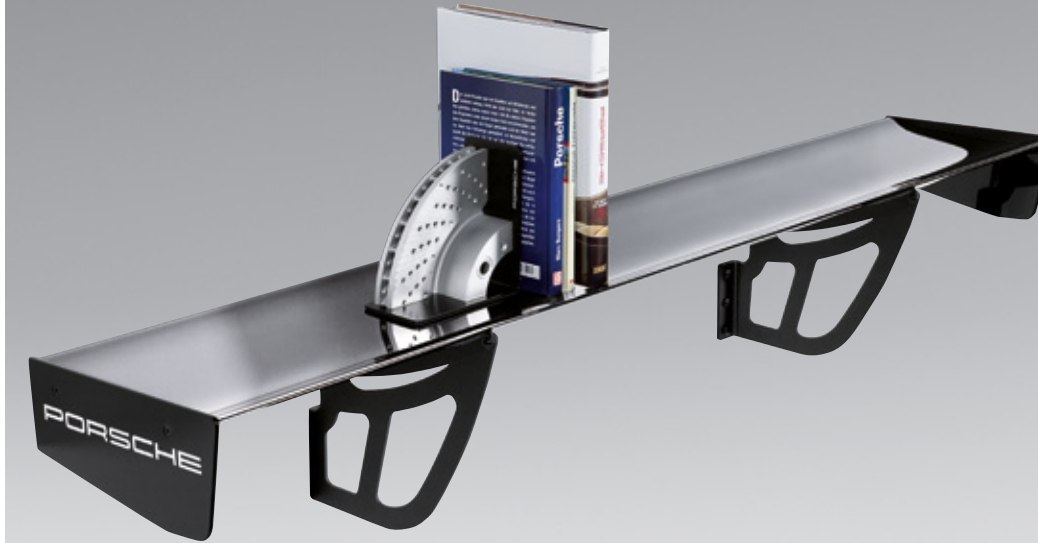

Wall shelving GT3 Cup

Original 911 GT3 Cup [991] rear spoiler. With 'PORSCHE' logo on the sides. With newly developed, black anodised aluminium brackets for convenient wall mounting. Carbon wings, painted in black. Weight: approx. 4–5kg. Max. load: 120kg. Dimensions [without brackets]: 171 × 30 × 15cm. Made in Germany.

WAP0500060E

DE MADE IN GERMANY
P PORSCHE ORIGINAL

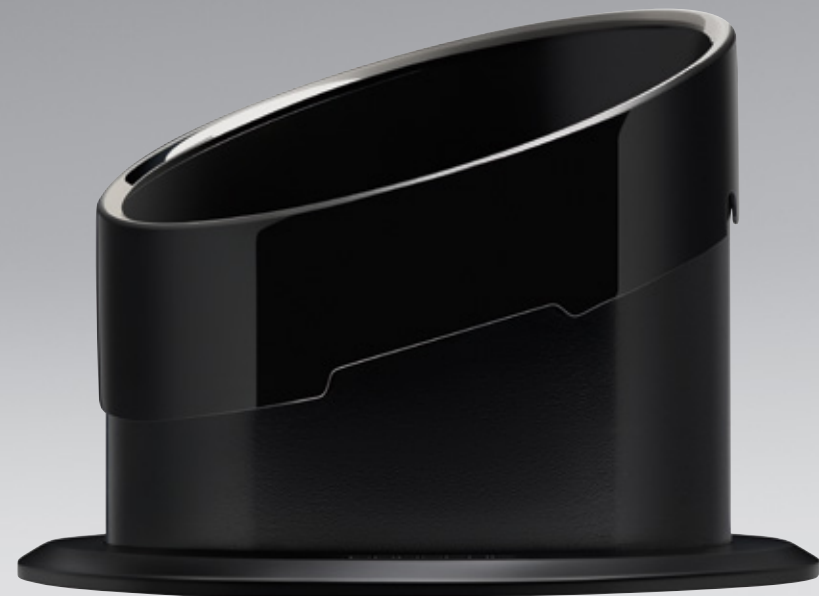

911 pen holder

High-quality pen holder with original tailpipe trim of the Porsche 911 Carrera [992] sports exhaust system. 90 % aluminium, 10 % plastic. In black. Incl. gift packaging. Made in Germany.

WAP0502000MSTH

DE MADE IN GERMANY
P PORSCHE ORIGINAL



911 Wireless Charging Piston

Modern, wireless charging technology meets Porsche genuine parts: the 911 Wireless Charging Piston is made from an original Porsche 911 Turbo [992] piston. Distinctive design by Studio F. A. Porsche. Matt black surface with Porsche Crest. Green LED light illuminates during charging; maximum output power 15 watts. USB type C connection, Made in Germany.

WAP0800010LWCP



Home and Office

The Porsche feeling: on your way to and from work. As well as the time between, thanks to home and office accessories from Porsche Driver's Selection. Because for everyone for whom time behind the wheel is often too little, Porsche Driver's Selection provides sporty accessories for everyday use. With office equipment, charming kitchen gadgets and exclusive accessories that afford sports car enthusiasm the space it deserves.

LE LIMITED EDITION



Collector's cup no. 4 – Limited Edition – 917 'Pink Pig'

Collector's mug no. 4 in porcelain. Limited to 10,000 units. Exclusive Porsche porcelain shape inspired by the Porsche Crest. In the design of the legendary 917 'Pink Pig'. Design by Studio F. A. Porsche. In high-quality gift packaging. Dishwasher-safe.

WAP0506700M917

LE LIMITED EDITION



Collector's espresso duo no. 4 – Limited Edition – 917 'Pink Pig'

Limited to 5,000 units. Set consisting of two espresso cups and saucers. Exclusive Porsche porcelain shape inspired by the Porsche Crest. Design by Studio F. A. Porsche, inspired by the legendary 917 'Pink Pig'. In high-quality gift packaging. Dishwasher-safe.

WAP0506600M917



Set of two highball glasses – 917 'Pink Pig'

Set of two high-quality highball glasses in the design of the legendary 917 'Pink Pig'. Design by Studio F. A. Porsche. Volume per glass: approx. 450ml.

WAP0506800M917



Thermo-insulated flask – 917 'Pink Pig'

Thermo-insulated flask made of double-walled stainless steel in the design of the legendary 917 'Pink Pig'. Fastener inspired by Porsche central locking. Volume: approx. 1.0l.

WAP0506900M917

DE MADE IN GERMANY



Collector's cup no. 5 – Racing Collection

Collector's cup no. 5 in 'Racing' design. Made of porcelain. Limited. Exclusive Porsche porcelain shape inspired by the Porsche Crest. Design by Studio F. A. Porsche. With high-quality gift packaging. Dishwasher-safe. Made in Germany.

WAP0504010NRTH

DE MADE IN GERMANY



Collector's espresso duo no. 5 – Racing Collection

Espresso cup set no. 5 in 'Racing' design. Made of porcelain. Limited. Exclusive Porsche porcelain shape inspired by the Porsche Crest. Design by Studio F. A. Porsche. With high-quality gift packaging. Dishwasher-safe. Made in Germany.

WAP0504020NRTH



New

LE LIMITED EDITION
DE MADE IN GERMANY



New

LE LIMITED EDITION
DE MADE IN GERMANY



New

LE LIMITED EDITION
DE MADE IN GERMANY



LE LIMITED EDITION
DE MADE IN GERMANY



LE LIMITED EDITION
DE MADE IN GERMANY



LE LIMITED EDITION
DE MADE IN GERMANY

Collector's cup no. 6 – Motorsport Collection

Collector's Cup no. 6 made of porcelain in the classic Porsche Motorsport colors. Exclusive Porsche porcelain shape inspired by the Porsche Crest. Design by Studio F. A. Porsche. In high-quality gift packaging. Capacity: approx. 500ml. Dishwasher-safe.

WAP0504040NMSC

Collector's espresso duo no. 6 – Motorsport Collection

Limited set, consisting of two espresso cups and saucers in the classic Porsche Motorsport colors. Exclusive Porsche porcelain shape inspired by the Porsche Crest. Design by Studio F. A. Porsche. In high-quality gift packaging. Capacity: approx. 85ml. Dishwasher-safe.

WAP0504050NMSE

Collector's Cup no. 3 – Limited Edition – 917 Salzburg

Collector's mug no. 3 celebrating the 50th anniversary of the 917 Salzburg. Made of porcelain. Limited to 10,000 units. Exclusive Porsche porcelain shape inspired by the Porsche Crest. Design by Studio F. A. Porsche and in the look of the overall winner of the 24h of Le Mans 1970 with start number 23. In red/black/white – the original racing colors. With high-quality gift packaging. Dishwasher-safe. Made in Germany.

WAP0506040M917

Collector's Espresso Duo no. 3 – Limited Edition – 917 Salzburg

Limited to 5,000 units. Set consisting of two espresso cups and saucers celebrating the 50th anniversary of the 917 Salzburg. Exclusive Porsche porcelain shape inspired by the Porsche Crest. Design by Studio F. A. Porsche and inspired by the look of the overall winner of the 24h of Le Mans 1970 with start number 23. In red/black/white – the original racing colors. In high-quality gift packaging. Dishwasher-safe. Made in Germany.

WAP0506050M917

DE MADE IN GERMANY



DE MADE IN GERMANY



DE MADE IN GERMANY



New



New



New

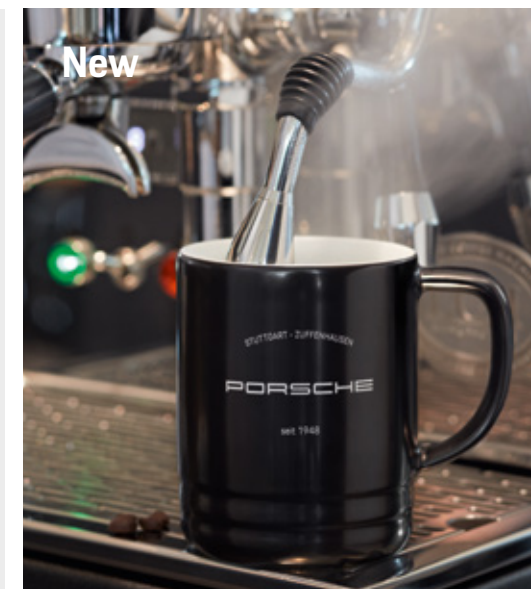

Porsche Crest cup standard

Small porcelain cup in exclusive design of Porsche, with two recessed grooves inspired by a Porsche engine piston. The Porsche Crest and the classic gold ring complete the new edition of the Crest cup. Design by Studio F. A. Porsche. With gift packaging. Dishwasher-safe. Made in Germany.

WAP0506060MSTD

Standard Porsche Crest cup large

Large porcelain cup in exclusive design of Porsche, with two recessed grooves inspired by a Porsche engine piston. Design completed with the Porsche Crest and classic gold ring. Design by Studio F. A. Porsche. With gift packaging. Dishwasher-safe. Made in Germany.

WAP0506070MBIG

Porsche Crest espresso duo

Set consists of two porcelain espresso duo cups with saucers in exclusive design of Porsche, with recessed groove inspired by a Porsche engine piston. Design completed with the Porsche Crest and classic gold ring. Design by Studio F. A. Porsche. With gift packaging. Dishwasher-safe. Made in Germany.

WAP0506080MESP

Standard Porsche Black Cup

The design by Studio F. A. Porsche with its two recessed grooves is based on the shape of a Porsche engine piston. The 'Stuttgart-Zuffenhausen PORSCHE since 1948' print makes it clear at first glance where the Porsche Black Cup got its inspiration. With gift packaging. Capacity: approx. 270ml. Dishwasher-safe. Made in Germany.

WAP0506010NCLC

Standard Porsche Black Cup Large

The design by Studio F. A. Porsche with its two recessed grooves is based on the shape of a Porsche engine piston. The 'Stuttgart-Zuffenhausen PORSCHE since 1948' print makes it clear at first glance where the Porsche Black Cup got its inspiration. With gift packaging. Capacity: approx. 420ml. Dishwasher-safe. Made in Germany.

WAP0506020NCLC



Two-piece set of long drink glasses – MARTINI RACING®

High-quality lead crystal glasses [machine-blown] in MARTINI RACING® design. Glass and refinement: motifs in the MARTINI RACING® colors. In blue/red/black. Made in Germany.

WAP0505000LOMR



Two-piece set of long drink glasses, Crest

With monochrome Porsche Crest in a set of two. Volume: approx. 450ml. Dishwasher-safe.

WAP0505010NLGL



Wine bottle stopper

Design inspired by the Porsche central locking mechanism.

WAP0501200G



Bottle opener

Design inspired by the Porsche central locking mechanism. For opening bottle tops.

WAP0501100G

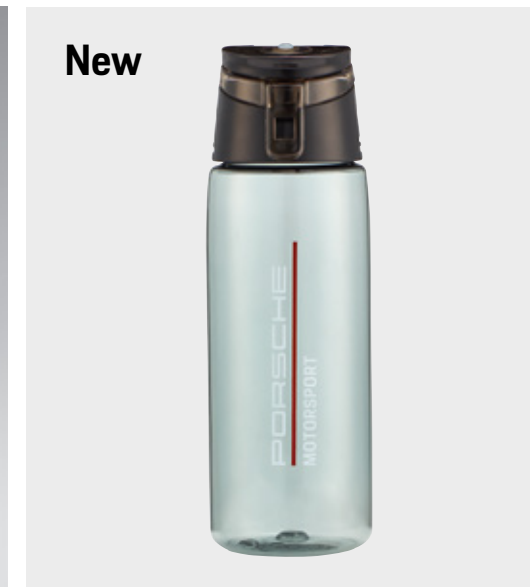

Drinking bottle – Motorsport Fanwear

Semi-transparent drinking bottle with screw cap and 'PORSCHE MOTORSPORT' signet. Ideal for on the road and on the race track. Capacity: approx. 735ml. Dishwasher-safe.

WAP0501270NFMS



Thermally insulated flask

Made of double-walled stainless steel. With the Porsche Crest on the body and the closure inspired by the central locking mechanism on Porsche models. Capacity: approx. 1l.

WAP0500620K



Glass decanter

With monochrome Porsche Crest. Design by Studio F. A. Porsche. The design of the lid is inspired by the Porsche fuel filler cap. The spout can be opened and closed with a 90° turn. Volume: approx. 1.4l.

WAP0505020NKGL



Thermally insulated flask – MARTINI RACING®

Made of double-walled stainless steel. With MARTINI RACING® design in dark blue and stripes in light blue/red. Fastener inspired by Porsche central locking. Capacity: 1.0l.

WAP0500620LOMR



Thermos cup – MARTINI RACING®

High-quality thermo-insulated cup with MARTINI RACING® design. Made of double-walled stainless steel. Leak-proof lid. Keeps hot drinks warm and cold drinks cool. Volume: approx. 0.45l.

WAP0505500K



Thermos cup – 911 GT3

High-quality thermo-insulated cup made from double-walled stainless steel. With the Porsche Crest on the body and embossed 'PORSCHE' logo on the lid. Keeps hot drinks warm and cold drinks cool. In Shark Blue. Volume: approx. 450ml.

WAP0500660MD5C



Thermal mug 'Pink Pig'

High-quality thermo-insulated cup made from double-walled stainless steel. Design inspired by the legendary 'Pink Pig' paintwork of the 917/20-001 from 1971. Porsche Crest on the body and embossed 'PORSCHE' logo on the lid. Keeps hot drinks warm and cold drinks cool. Capacity: approx. 450ml. Includes high-quality gift packaging.

WAP0506250L917



Thermos cup

High-quality thermo-insulated cup made from double-walled stainless steel. Leakproof lid. With the Porsche Crest on the body and embossed 'PORSCHE' logo on the lid. Keeps hot drinks warm and cold drinks cool. Volume: approx. 0.45l.

WAP0500630H [black],
WAP0500640H [stainless steel]



Thermos cup – Racing Collection

High-quality thermo-insulated cup made from double-walled stainless steel in the legendary 'Racing' design. Leakproof lid. With Porsche Crest on the body and embossed 'PORSCHE' logo on the lid. Keeps hot drinks warm and cold drinks cool. Volume: approx. 450ml.

WAP0504030NRTH



Thermos cup XL

High-quality thermo-insulated cup made from double-walled stainless steel, powder-coated in black. Leakproof lid. With Porsche Crest on the body and embossed 'PORSCHE' logo on the lid. Keeps hot drinks warm and cold drinks cool. Volume: approx. 900ml.

WAP0500680M002



Ice cube tray

Makes 911 shaped ice cubes. Also perfect for making chocolates. Made of silicone.

WAP0500160F



Salt and pepper mills

Set of two mills with high-quality ceramic grinding mechanism. The top is inspired by the design of the Porsche central locking mechanism. Adjustable grinding level. Made of stainless steel. Height: approx. 18cm. Diameter: 4.5cm.

WAP0500140E



Table clock – MARTINI RACING®

Design based on the Sport Chrono clock of Porsche vehicles. In MARTINI RACING® design. Alarm and countdown function. Alarm with engine sound. Analogue and digital time display. LCD display. Digital time display either in 12- or 24-hour format. Calendar display in two formats: day-month-year or month-day-year. Height: approx. 11.5cm. In black/white/dark blue/light blue/red.

WAP0701020KOMR

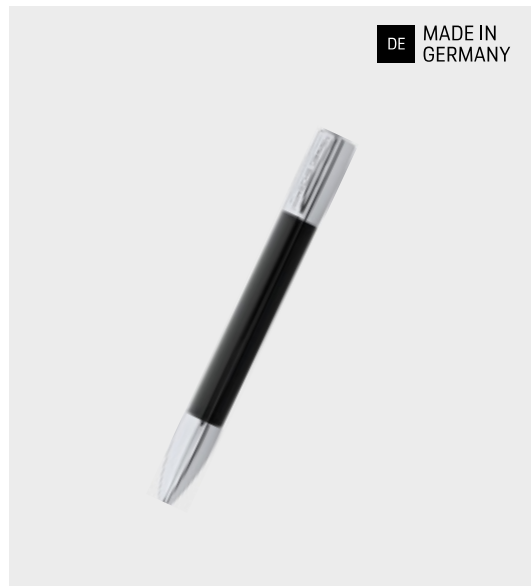

Shake Pen

Exclusive Porsche Design writing tools with an innovative operating mechanism: the point can be extracted and retracted at a flick of the wrist. Natural rubber grip in black. Ends in matt chrome. 'PORSCHE DESIGN' logo at end. Made in Germany.

WAP3140BPOK101



Shake Pen Carbon

Exclusive Porsche Design writing tools with an innovative operating mechanism: the point can be extracted and retracted at a flick of the wrist. Carbon grip in black. Ends in glossy stainless steel. 'PORSCHE DESIGN' logo at end. Made in Germany.

WAP3140BPOK103

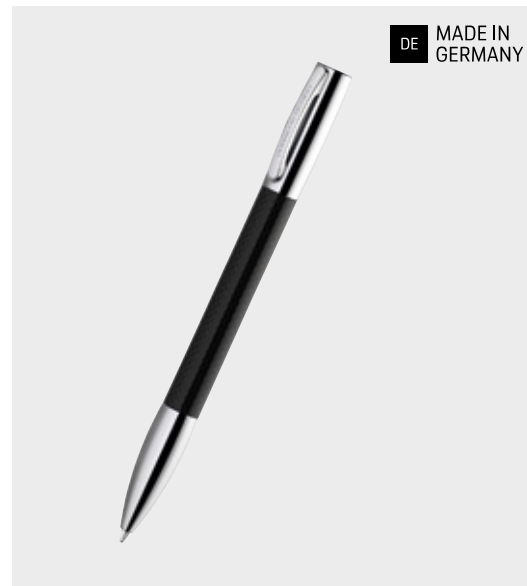

Shake Pen Big Carbon

Exclusive Porsche Design writing tools with an innovative operating mechanism: the point can be extracted and retracted at a flick of the wrist. Carbon grip in black. Ends in glossy stainless steel. 'PORSCHE DESIGN' logo on the stainless steel clip at the end. Made in Germany.

WAP3142BPOK100

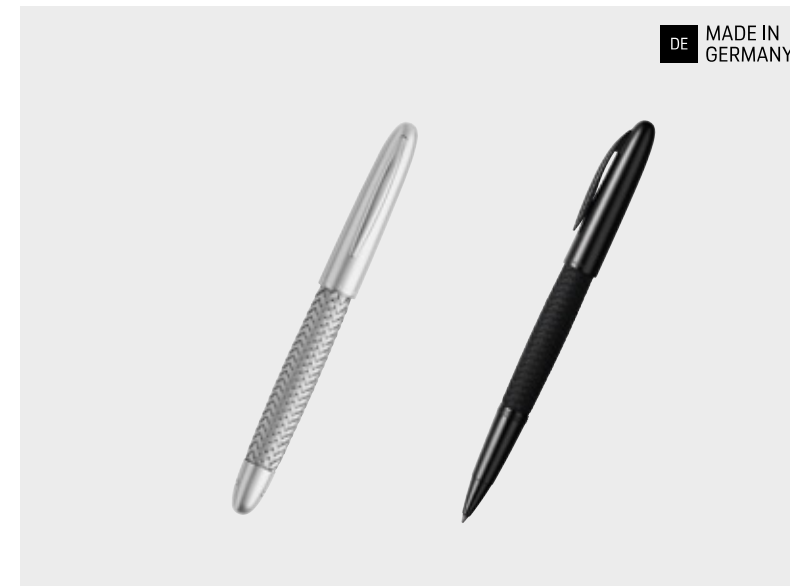

Tec Flex Rollerball Pen

Stylish writing implements from Porsche Design. The highly technical braid made of elaborately woven stainless steel threads is elastic. Front and end are made of brass and refined with a palladium coating. Sealing cap with clip. Made in Germany.

WAP3110RBOK202320 [silver color],
WAP3110RBOK100365 [black]

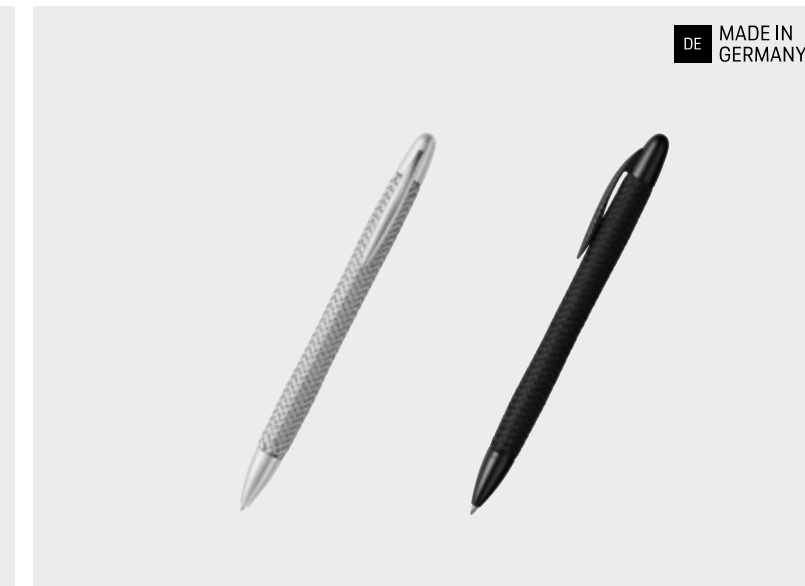

Tec Flex Ballpoint Pen

Stylish ball-point pen from Porsche Design with extraordinary operating mechanism: the highly technical braid made of elaborately woven stainless steel threads is elastic and contracts when the mechanism is operated. Front and end are made of brass and refined with a palladium coating. Made in Germany.

WAP3110BPOK202200 [silver color],
WAP3110BPOK100260 [black]

DE MADE IN GERMANY



Porsche seat barrel – 917 Salzburg

Authentic barrel to be used as seating furniture. With 917 Salzburg design and padded seat. Suitable for indoor and outdoor use. Height approx. 60cm. Made in Germany.

WAP0501010MSFS

DE MADE IN GERMANY



Porsche seat barrel – 917 'Pink Pig'

Authentic barrel to be used as seating furniture. With 917 'Pink Pig' decal and padded seat. Suitable for indoor and outdoor use. Height approx. 60cm. Made in Germany.

WAP0501020MSFS

DE MADE IN GERMANY



Porsche seat barrel – MARTINI RACING®

Authentic barrel to be used as seating furniture. With MARTINI RACING® Design and padded seat. Suitable for indoor and outdoor use. Height approx. 60cm. Made in Germany.

WAP0501000MSFS



Leather mouse pad

Mouse pad in the shape of the Crest with embossed 'PORSCHE' logo. Non-slip underside. Made of leather.

WAP0500020MPAD

New

DE MADE IN GERMANY



Christmas tree ornament

Hand-painted Christmas tree ornament from the Collector's Edition no. 1 in the shape of the original 911 with Christmas tree. In Christmas gift packaging. Made in Germany.

WAP0500100NWKG

New

DE MADE IN GERMANY



Christmas tree ornament

Hand-painted Christmas tree ornament from the Collector's Edition no. 2 in the shape of the original 911 with Christmas tree. In Christmas gift packaging. Made in Germany.

WAP0500100NWKG

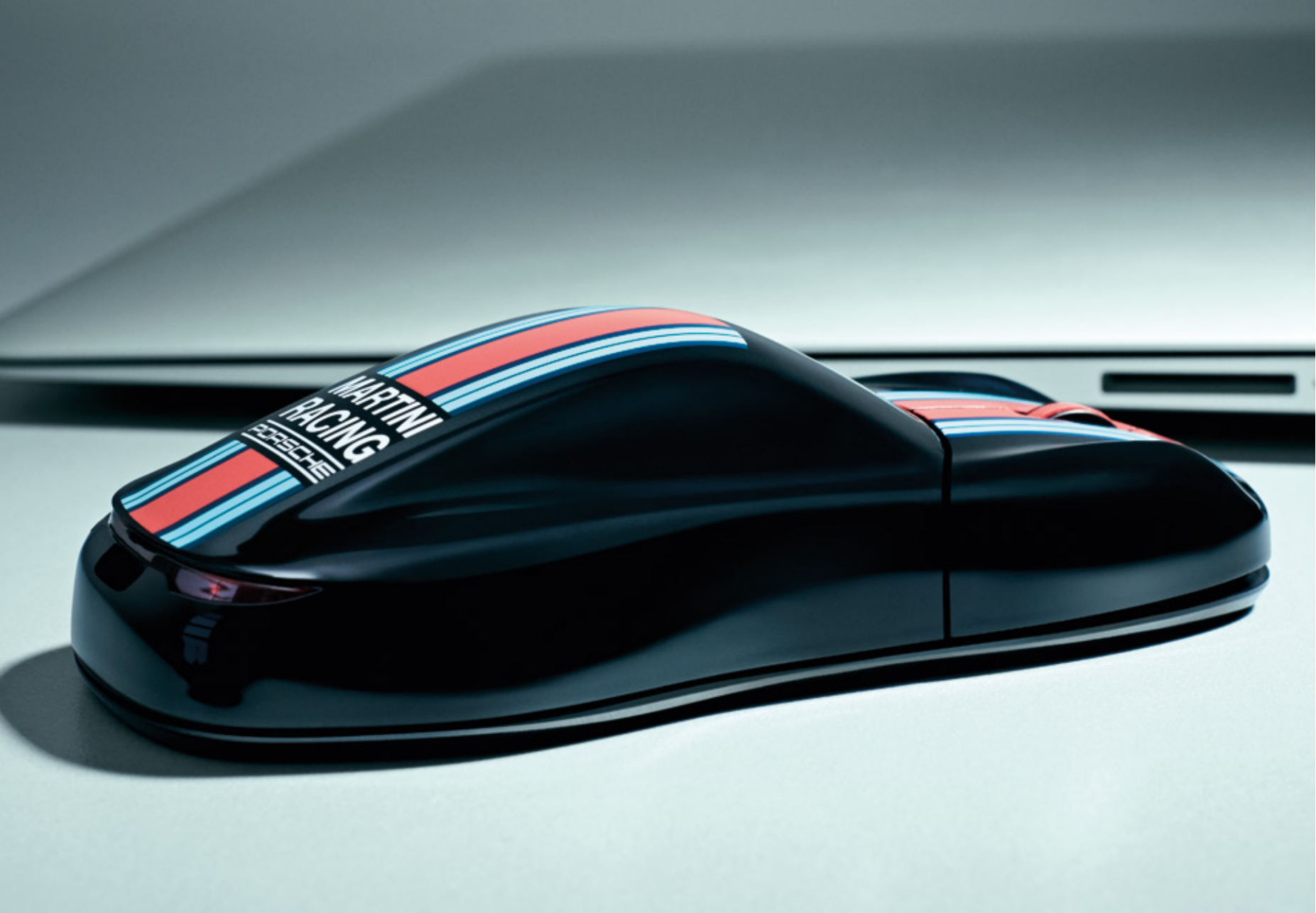

Electronic devices

We believe that every form of mobility deserves authentic Porsche Performance – including digital devices. So, Porsche sports accessories should also include electronic devices.

Porsche Driver's Selection therefore offers a range of products featuring detailed Porsche miniatures as USB sticks, high-quality computer accessories and exclusive sound devices that allow sports car enthusiasts to apply the racing line to their bits and bytes.



USB stick – car key

USB stick with 64GB storage capacity. In the timeless design of the current Porsche car key.

WAP0507150M001



Computer mouse – MARTINI RACING®

Wireless mouse with typical MARTINI RACING® look. Taillight strip illuminates when used. Ergonomically optimised shape. Made of plastic. In black/blue/red.

WAP0808100K



917 Wireless computer mouse

Wireless connection: this mouse in the red and white design of the legendary Porsche 917 with start number 23 can be easily connected to a PC via a wireless connection. Its ergonomic design means that you can work comfortably even over long distances.

WAP0508110M917





Calendars and books

The calendars and books from Porsche Driver's Selection allow Porsche enthusiasts to extend Fascination Sportscar to their everyday lives, page by page. As a note book for their next meeting, sketch pad for visionary ideas or exclusive wall calendar, they stylishly express their owners' sports car passion – and ensure 365 days of inspiration a year as they explore the sports car of the future.

Exclusive highlights for collectors: the two Limited Editions featuring high-quality art prints and authentic miniatures of the legendary Porsche models in an elegant collector's box.

New



DE MADE IN GERMANY

Porsche Calendar 2022

Fascination Porsche. Immense emotions like no other – just like the models in the Porsche Calendar 2022, which is not called 'One of 1' for nothing, presenting 12 very special Porsche models. Like, for example, the 911 GT3 R Hybrid, the 911 Turbo in 'Cyberpunk 2077 Look' unfortunately only available online, or the 911 Carrera 4, 993 type, which was built in the course of the unbelievable 100,000km of the mega test, under the toughest conditions – thus earning itself a place the Guinness Book of Records. In short: 12 different one-offs, prototypes and studies that are guaranteed to make Porsche fans' hearts race. High-quality printing, including strictly limited collector's coin and robust outer packaging. Dimensions: 59 × 55.5cm.

WAP0920010N



'From 0 to 911'

This illustrated children's book allows young and old alike to immerse themselves in the history of their favourite car: the Porsche 911. They can discover all about the initial concepts, learn how a Porsche is built and get to know the various models.

WAP0409110JDEU



'70 Years of Porsche Sports Cars'

The history of the sports car icon, Porsche 911 – from then until now. Images, drawings and adverts from the works archive inventory. 70 years of illustrated Porsche history, tradition and evolution, supplemented by technical text.

WAP0920700K



DE MADE IN GERMANY

Notebook

Cover in black. 90g/m². Perforated for easy tearing. With ballpoint pen and filing system in the front section. Dimensions: 15 × 18.8cm. Made in Germany.

WAP0920050D



DE MADE IN GERMANY

Poster set – 917 'Pink Pig'

Poster set consisting of two posters. Motif 1: 917/20 'Pink Pig'. Motif 2: exclusively designed racing poster 'Pink Pig back on track'. Dimensions: 50 × 70cm.

WAP0924500M917

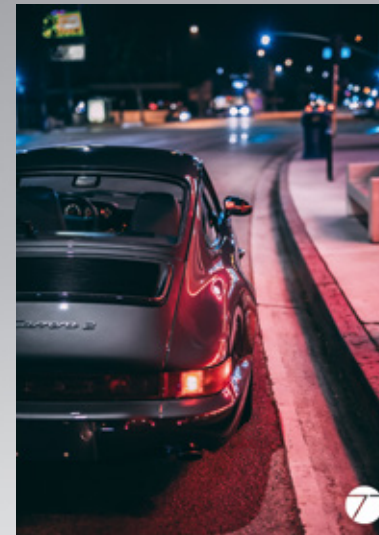
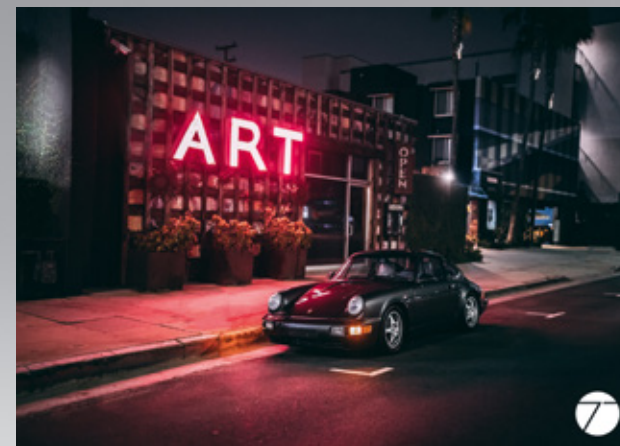

DE MADE IN GERMANY

Poster set Type 7

The sides of a Porsche are as smooth as chocolate: as demonstrated by the artfully photographed motifs by Stephan Bauer, who accompanied and supported the Type 7 from the outset. For this exclusive poster set, consisting of two motifs, he perfectly captured the Porsche 964 under the shimmering neon lights of L.A. A tribute to a special car and a special collaboration. Dimensions: 50 × 70cm.

WAP0924600MTP7



Leather accessories

Durability and suppleness. Natural feel and exclusive look. High-quality leather has a particular fascination for many people, with the harmonious joining of apparent opposites. The small leather goods from Porsche Driver's Selection lend the exclusive material a further component: personality.

Thanks to careful workmanship and subtle branding, the charismatic leather products have the potential to accompany their owners for a long time, and to become truly favourite pieces – embossed with the 'PORSCHE' logo or Porsche Crest.



Men's wallet – Heritage

Wallet in high-quality cowhide leather with embossed Porsche logo. With coin and various other compartments. Banknote compartment with divider. 60% cowhide leather, 30% polyester, 10% microfibre. In Asphalt Grey with detailing in Bordeaux Red. Made in Europe.

WAP0300350LHRT



Credit card case – Heritage

Credit card case in high-quality cowhide leather with embossed Porsche logo. With eight compartments for credit cards and additional compartments. Banknote compartment with divider. 60% cowhide leather, 30% polyester, 10% microfibre. In Asphalt Grey with detailing in Bordeaux Red. Made in Europe.

WAP0300360LHRT



Men's wallet

Made of high-end cowhide with embossed Porsche Crest. With compartment for notes and coins as well as various slit pockets and a mesh pocket. Dimensions: approx. 12 × 9.5 × 1.5cm. In black.

WAP0300310K



Women's purse

Made of high-end cowhide with an embossed Porsche Crest. With practical internal layout and various compartments. Dimensions: approx. 19 × 11 × 2.5cm. In black.

WAP0300300K



Credit cardholder

Made of high-quality cowhide leather. With embossed Porsche Crest. Dimensions: approx. 10.5 × 8.5 × 1.0cm. In black.

WAP0300360K

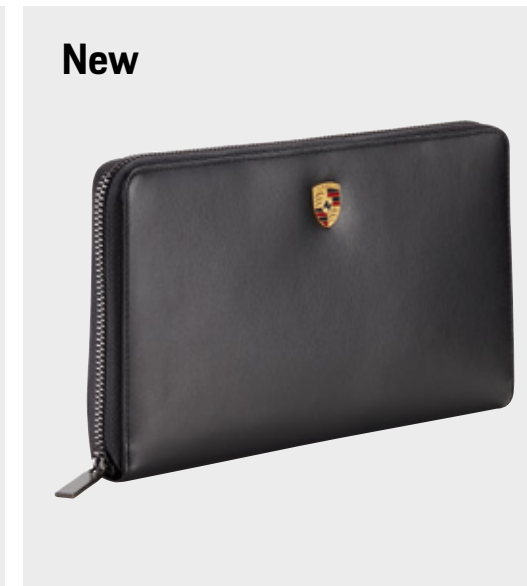
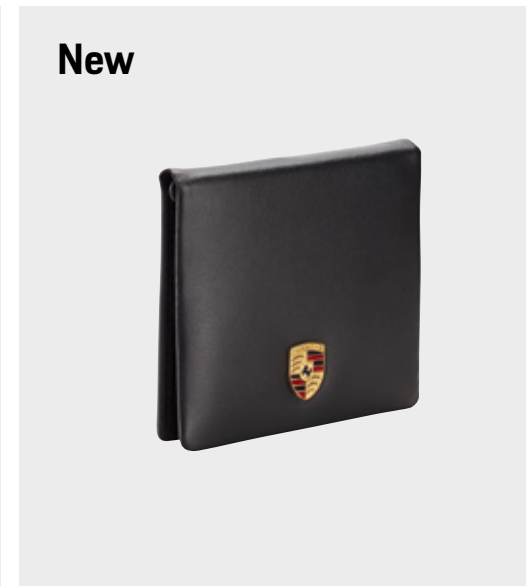
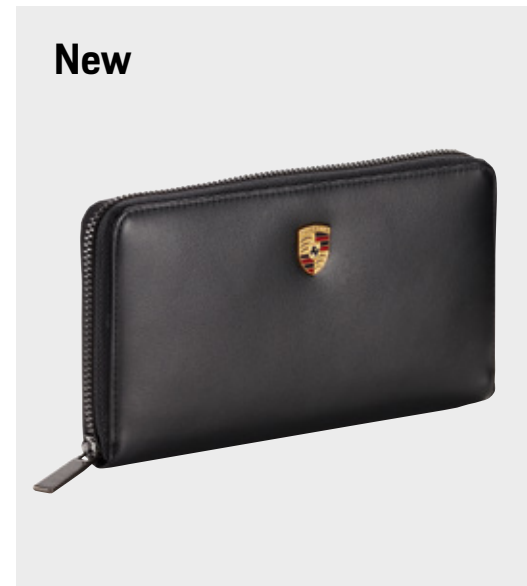
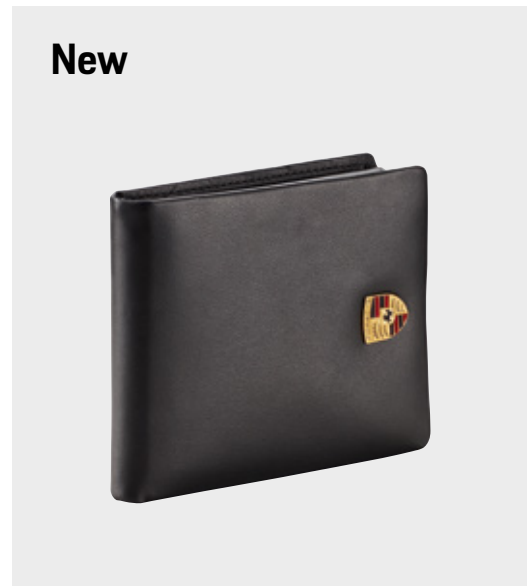

Combination folder

Made of high-end leather with embossed Porsche Crest. Ideal for travel documents, credit cards and writing utensils as well as for holding your vehicle papers. Dimensions: approx. 23 × 14 × 2.5cm. In black.

WAP0300350K

Men's wallet

Wallet made of high-quality cowhide leather with fine metal Porsche Crest on the outside. With 12 slots for bank and business cards Mesh pocket for identity card or driving licence. Large zipped pocket for coins.

WAP0300200GBH

Women's purse

Purse made of high-quality cowhide leather with colorful Porsche Crest on the outside. With eight slots for cards. Large zipped pocket for coins.

WAP0300210NGBD

Credit card holder with money clip

Credit card holder made of high-quality cowhide leather with fine metal Porsche Crest on the outside. With eight slots for cards and a large slip pocket at the back. Including money clip.

WAP0300300NKEG

Travel brief case

Combi-case made of high-quality cowhide leather with subtle metal Porsche Crest on the outside. With seven slots for cards and three large pockets for documents, as well as a key and pen ring.

WAP0300220NRBT

New



Key pouch

Key pouch made from cowhide leather with high-quality metal Porsche Crest on the outside. Suitable for all Porsche system keys.

WAP0300400NSLT

New



Key pouch

Made of high-end cowhide with embossed Porsche Crest. In black.

WAP0300370K



Essential Collection unisex reversible belt

Reversible leather belt with pin buckle. Adjustable standard length [140cm]. With Porsche logo on the buckle. Including gift packaging. Made in Germany. Belt: 100% cowhide leather. Buckle: 100% zamac. In black/brown. Made in Germany.

WAP6600090MESS



Men's leather gloves – Classic

Men's driving gloves with double-row perforations on front and back. Four notches, secured with stitches, at each knuckle. Back of the glove with press stud made of antique brass and 'PORSCHE' logo. No lining. 100% nappa lambskin. In black. Available in sizes S, M and L.

WAP519001-0030H



Women's leather gloves – Classic

Women's driving gloves with all-over perforation on the back of the glove and smooth-finish leather on the palm. Four notches with piped seam at each knuckle. Back of the glove with press stud made of antique brass and 'PORSCHE' logo. No lining. 100% nappa lambskin. In black. Available in sizes S, M and L.

WAP518001-0030H



Accessories

Functional or elegant? Unusual or suitable for everyday use? At Porsche, either/or has never been an option. Only when everything functions perfectly together and works as an intelligent overall concept has an idea earned the Porsche Crest.

A claim to which the accessories from Porsche Driver's Selection are also committed in every respect: with exquisite materials, sporty, elegant designs, intelligent details and uncompromisingly high-quality workmanship. Which turns these exclusive accessories into everyday items that are anything but commonplace.



Lanyard – 911 GT3

Short lanyard – inspired by the 911 GT3 door loop. With Porsche logo, carabiner, 1 × standard key ring, 1 × small key ring. In blue.

WAP0508010MGT3



Lanyard – MARTINI RACING®

Lanyard with removable key ring and aeroplane buckle. In the typical MARTINI RACING® colors. Woven 'PORSCHE' logo. 'MARTINI RACING® PORSCHE' rubber badge. One large key ring and small key ring. Strap: 100% polyester. Carabiner: 100% zinc alloy. In blue/red.

WAP5500030LMRH



Lanyard – GT4 Clubsport

Lanyard with removable holding net for smartphones with card slot [100% silicone]. Includes carabiner, two key rings [in two sizes] and safety clasp made of 100% plastic. Inspired by the vehicle design of the 718 Cayman GT4 Clubsport. Strap: 100% polyester. Carabiner and key ring: 100% metal. In black/yellow.

WAP3400020LCLS



Lanyard – Transaxle Collection

Lanyard inspired by the look of the Porsche 928 fan belt. With printed 'PORSCHE' logo and original part number. Includes carabiner, key ring and safety clasp. Strap: 100% polyester. Metal carabiner with plastic clasp. In black/white.

WAP4200030KHTP



Lanyard – Motorsport

Lanyard based on the design of the seat belts in Porsche race cars. With 'PORSCHE MOTORSPORT' badges and safety clasp. Adjustable size. Strap: 100% polyester. In black/red.

WAP8000030J

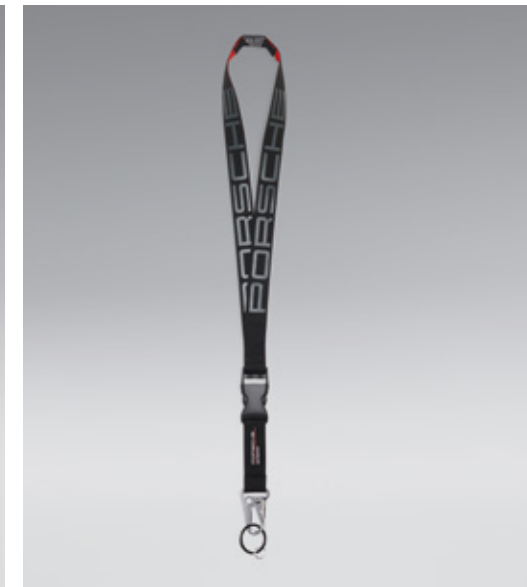

Lanyard – Motorsport Fanwear

Lanyard with 'PORSCHE' logo and safety breakaway clip. Including removable key ring with 'PORSCHE MOTORSPORT' signet. 80% polyester, 10% plastic, 10% metal. In black.

WAP0500030LFMS



Laser key ring – Motorsport Fanwear

Key ring in stainless steel with lasered 'PORSCHE MOTORSPORT' signet. 90% zinc alloy, 10% metal. In silver color.

WAP0500060LFMS [lasered],
WAP0500050LFMS [with colored engraving]

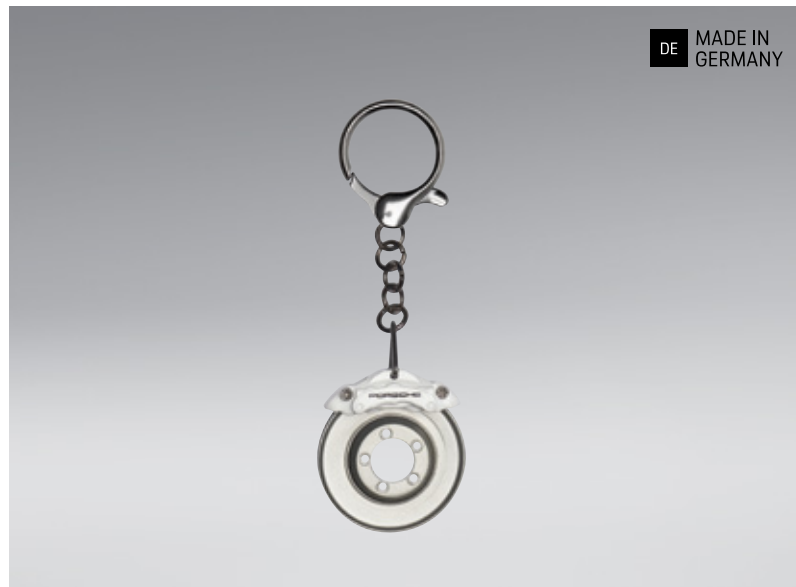

Brake-disc key ring

With a true-to-original rotating Porsche brake disc. Suitable for all Porsche car keys. Diameter: 3.5cm. Made in Germany.

NEW. WAP0303050L [white]



Crest key ring

Genuine leather. Suitable for all Porsche car keys. Made in Germany.

WAP0500960E [white],
WAP0500980H [beige],
WAP0500920E [red],
WAP0500950E [blue],
WAP0500900E [black],
WAP0500300MM3B [Star Ruby]

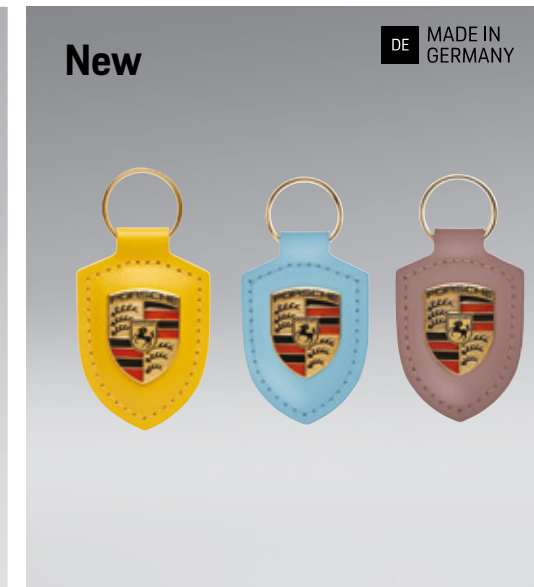

Crest key ring

Crest key ring. Real leather. Suitable for all Porsche vehicle keys. Made in Germany.

WAP0500200M12H [Speed Yellow],
WAP0500310NWSA [Frozen Blue],
WAP0500320NWSA [Frozen Berry]



Crest key ring – Heritage

Real leather. Suitable for all Porsche vehicle keys. Including gift packaging. Made in Germany. Ring: brass. In beige, gold color. Made in Germany.

WAP0500900LHRT



917 grille badge – MARTINI RACING®

Grille badge with image of the 917 KH MARTINI RACING® that took the second overall Porsche victory in the legendary 24-hour race at Le Mans in 1971. Diameter: 95mm. Made of 95% zinc, 5% acrylic varnish. Made in Germany.

WAP0508100MOMR



Grille badge – 917 Salzburg

Diameter: 95mm. Made of 95% zinc, 5% acrylic varnish. With fixing material [screws]. In red/white – like its motorised role model. Made in Germany.

WAP0509170MSZG





Grille badge – Limited Edition – MARTINI RACING®

Limited to 2,000 pieces. Diameter: 95mm. Made of metal. With fixing material [screws]. In dark blue/red/silver color. Made in Germany.

WAP0508100LOMR



Porsche Crest cufflinks

Made of enamelled 925 sterling silver. Partially gold-plated. Size: approx. 13 × 18mm.

WAP05014015



Stickers – Crest

It sticks with you – just like your love of Porsche: tell the world what makes your heart beat faster with a sticker in the shape of the Porsche Crest, which can be used indoors and outdoors.

WAP01300050MCST



Porsche Crest stick pin

Made of metal. Size: approx. 10.0 × 13.5mm. Length: 51.5mm.

WAP104500

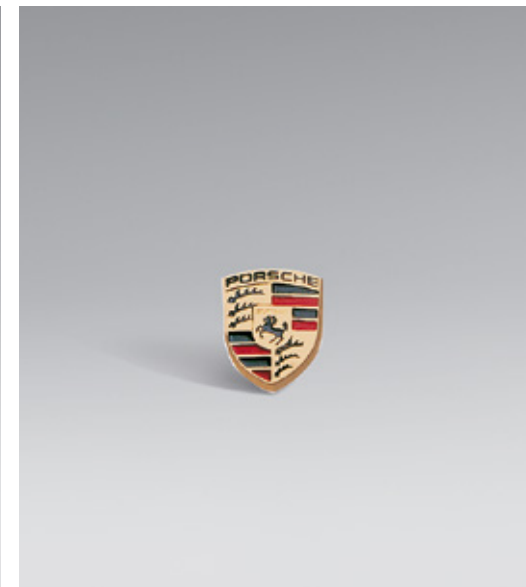

Porsche Crest button

Made of metal. Size: approx. 10 × 13mm.

WAP10705010



Porsche Crest sew-on badge

100% polyester. Size: 53 × 65mm.

WAP10706714



Snap-on case for iPhone 12 mini

iPhone case in typical MARTINI RACING® look or with a leather surface. Volume buttons as well as recesses for camera, speaker and microphone.

WAP0300100MSOC [MARTINI RACING®],
WAP0300140MSOC [genuine leather with full-color Porsche Crest]

Snap-on case for iPhone 12/12 Pro

iPhone case in typical MARTINI RACING® look or with a leather surface. Volume buttons as well as recesses for camera, speaker and microphone.

WAP0300110MSOC [MARTINI RACING®],
WAP0300150MSOC [genuine leather with full-color Porsche Crest]

Snap-on case for iPhone 12 Pro Max

iPhone case in typical MARTINI RACING® look or with a leather surface. Volume buttons as well as recesses for camera, speaker and microphone.

WAP0300160MSOC [MARTINI RACING®],
WAP0300180MSOC [genuine leather with full-color Porsche Crest]



Umbrella – MARTINI RACING®

Umbrella in MARTINI RACING® design – provides protection against rain and sun. Includes a sleeve with a practical shoulder handle for easy transport. Comfortable opening by means of a handy slide. High-quality windproof system for maximum frame flexibility, even in strong winds. Rails and two-piece pole made of stable fibreglass, lower pole with tip for fixing in the ground. Suitable for suitcases due to space-saving travel size.

WAP0500820MSMR



Car umbrella L

Exceptionally stable design and, despite its size, comfortably light. Ergonomically formed handle with special coating and has a Porsche Crest on the underside. 100% polyester. In black.

WAP0505700L

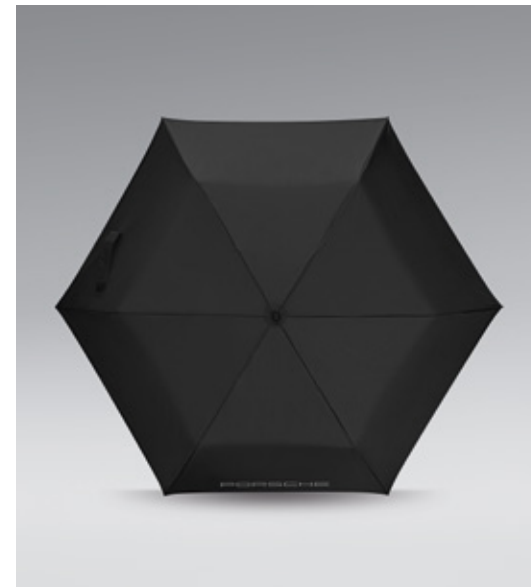

Vehicle pocket umbrella

Extremely lightweight and robust pocket umbrella, ideal for storing in the side door compartment of the new 911. With highly flexible frame construction and windproof system. Length [opened]: approx. 68.5cm, length [closed]: approx. 34.5cm. 100% extra-light polyester pongee. In black with silver-colored details.

WAP0500800L



Umbrella XL – MARTINI RACING®

Large umbrella with double cover and MARTINI RACING® print motif from the 917 Longtail of 1971. With Dupont Teflon coating and silver-colored elements. Windproof system with fibreglass spokes. Plastic handle with '21' logo on the bottom. Length [closed]: 88.5cm. Diameter: approx. 120cm. In dark blue.

WAP0505700J



Flag – Motorsport Fanwear

Fan flag with 'PORSCHE MOTORSPORT' signet. Dimensions: 90 × 60cm. 100% polyester. In black. Made in Germany.

WAP0500070LFMS



Racewear

Sometimes, your passion for motorsports is too big even for a place in the grandstands. With the Porsche Motorsport team Racewear Collection, any Porsche fan can become a racing driver.

The collection enables you to kit yourself out professionally from head to toe, equipping you to take on any race track. Whether at weekends on the Nürburgring, or as a driver in a racing series.

The made-to-measure equipment complies with the applicable FIA safety standards, and is available either in the style of the current works team or in a nostalgia-inspiring style featuring classic design elements.



La Couture HSC*

Homologations: FIA 8856-2000 and SFI 3.2A Level 5.
 Technological highlight and unique style. Breathable and stretchy. Pre-formed sleeves with fluid Aramid armholes. Numerous stretchy comfort zones.

La Couture Hybrid*

Homologations: FIA 8856-2000 and SFI 3.2A Level 5.
 A perfect racing suit combination: ultra-light and extremely breathable. Numerous stretchy comfort zones. Pre-formed sleeves with fluid Aramid armholes. Internal belt to protect against injury.



ST3000 HSC*

Optimised performance, comfort and safety. Two layers. Breathable, elastic material. Integrated pockets, flat internal seams and soft collar. Pre-formed sleeves with fluid Aramid armholes. Sizes: from 0 to 6 and made-to-measure.



IVOS – Double Duty FIA*

Ultra-light to relieve neck muscles. Latest technology and exceptional strength for maximum safety. With carbon outer shell, inner lining made of memory foam and optional air intakes [at extra cost]. FHR-compatible. Includes transparent visor, face shield and a set of screws. Sizes: 57 to 65 and made-to-measure.



IVOS – Double Duty SNELL*

Ultra-light to relieve neck muscles. As well as the latest technology and exceptional strength for maximum safety. With carbon outer shell, inner lining made of memory foam and optional air intakes [at extra cost]. FHR-compatible. Includes transparent visor, face shield and a set of screws. Sizes: 57 to 65 and made-to-measure.



IVOS – Jethelm SNELL*

Homologations: SNELL SA 2015/FIA 8859-2015. The freedom of an open-face helmet with the safety of an FHR system. As well as the latest technology and exceptional strength for maximum safety. With carbon outer shell and inner lining made of memory foam. FHR-compatible. Includes face shield. Sizes: 57 to 65 and made-to-measure.



FHR helmet bag – Porsche Motorsport*

A must for transporting your helmet: a lined, reinforced helmet bag made of high-quality polyester. Suitable for a helmet and one to two FHRs. In black.



Porsche Motorsport helmet bag*

Simple and practical. Lined with polyester. And featuring the Porsche Motorsport logo. In black.



OUTSIDE SEAMS II*

Homologations: FIA 8856-2000 and SFI 3.3/5. Anti-vibration foam. Grip and protective inserts to avoid blisters. Pre-formed palms and fingers made of Aramid fabric. Fireproof patch on the back of the hand. External seams for improved wear and comfort. Adjustable Aramid strap. Made from the finest leather and Aramid jersey. With Porsche Motorsport logo. Sizes: 6 to 12.



Air-S Speed Porsche Motorsport*

Homologation: FIA 8856-2000. Made of stretchy, breathable and fireproof material. With reinforced heel and ergonomically rounded ATV hydrocarbon sole to prevent the shoe from getting caught. Firm fit, as laces extend to your ankle. Sizes: 36 to 47.



Daytona II race shoe – Porsche Motorsport*

Homologations: FIA 8856-2000 and SFI 3.3/5. Low-cut, premium-quality shoes with reinforced anti-vibration heel and ergonomically shaped sole. Additional quick-release Velcro fastener for a firm fit. European sizes: from 36 to 47. In Porsche Motorsport design.



Silhouette race shoe – Porsche Motorsport*

Approvals: FIA 8856-2000 and SFI 3.3/5. Suitable for narrow cockpits with limited space. Inner layer made of red Aramid and new exclusive sole for improved pedal contact. With ankle padding, micro-cellular, shock-absorbing EVA heel and ergonomically rounded ATV hydrocarbon sole. Firm fit thanks to the new lace system that extends to your instep and Velcro ankle strap. With PORSCHE logo. Sizes: 36 to 47 and US.



Children

The passion for efficient engines, intelligent technology and aerodynamic design rarely starts with getting your driving licence. More often, sports cars have a particular fascination for the very young. To bridge the gap to fulfilling the dream of owning their own Porsche, Porsche Driver's Selection offers a large selection of toys and sporty children's clothing.

The children's products, as with all products that bear the Porsche Crest, have been manufactured according to highest quality standards and subjected to meticulous inspections. Safety is a top priority after all, both for our little and for our bigger racing car drivers.



Kids' polo – 917 Salzburg

Short-sleeved polo shirt with three buttons and 'PORSCHE' print on the chest. With '23' badge on the sleeve. 'PORSCHE' and '917' print on the back. Piqué. In 100% cotton. In red/white/black.

WAP463098-1640MSZG



Kids' T-shirt – 917 Salzburg

Short-sleeved T-shirt for children with '917' appliqué and 'PORSCHE' print in white. Soft jersey material: 50% cotton and 50% polyester. Unisex. In grey melange.

WAP461 098-1640MSZG



Kids' hoodie – 917 Salzburg

Hoodie for children. With '917' appliqué and 'PORSCHE' print in white. Soft sweater material in 60% cotton and 40% polyester. Unisex. In grey melange.

WAP464098-1640MSZG



Kids' cap – 917 Salzburg

Stylish baseball cap for children. Front panel printed with the Porsche 917 Salzburg logo. Top of visor with white print design, inspired by the Porsche 917 Salzburg paintwork. Side print with numbers '23' and '917'. With freely adjustable Velcro fastener in black to adjust the size. Material: 100% cotton. In grey melange/black/red.

WAP4600010MSZG



Baby set – 917 Salzburg

Baby set including gift packaging – inspired by the Porsche 917 Salzburg. Bib, T-shirt and trousers with appliqués. One size available [62/68]. Made of soft cotton jersey: 62% polyester, 35% cotton, 3% elastane. In grey melange/black/red.

WAP4650020MSZG



Baby romper – Motorsport

Long baby romper inspired by the Porsche Motorsport team clothing. With feet and press studs on the front and on one leg. One size available [age 3–6 months]. 100% cotton. Incl. gift packaging. In black/white/red.

WAP4300620K



Unisex children's Le Mans T-shirt 'Pink Pig' – Motorsport

Unisex fan T-shirt with all-over print. Design inspired by the legendary 'Pink Pig' paint finish of the 917/20 from 1971. In 2018, the 911 RSR [no. 92] competed at Le Mans bearing the same paint finish and won the race in its class. Very soft quality T-shirt. 100% cotton. In pink/red.

WAP435098-1580KOMS



'Pink Pig' fluffy blanket

Cuddly fluffy blanket in the shape of a pig and in the legendary 917 'Pink Pig' design.

WAP0400020MOST

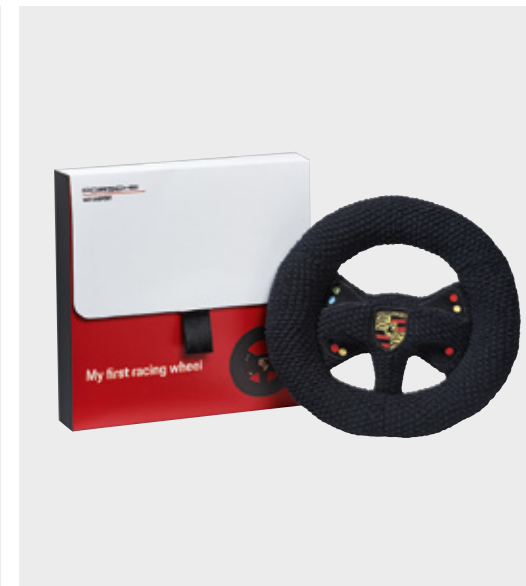

Knitted steering wheel with rattle – Motorsport

In the style of the original steering wheel in the Porsche Motorsport vehicles. Knitted with embroidered buttons and Porsche Crest. Washable at 30°C. 95% cotton, 3% polyester, 2% viscose. Including gift packaging. In black/red.

WAP0409010K

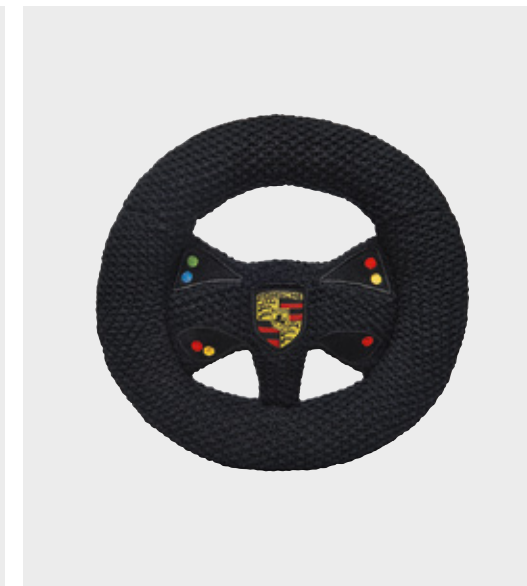

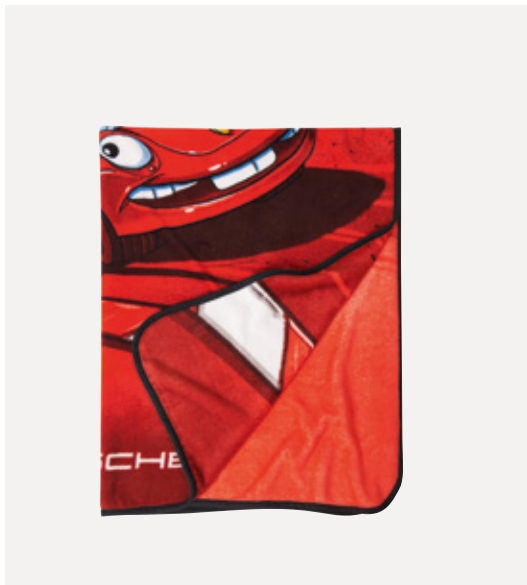

Children's snuggle blanket

Made for long car journeys: soft blanket with Porsche motif and logo. Front and back in red.

WAP0401000LKID



Children's snuggle cushion

Soft cushion with Porsche motif and logo, as the perfect companion for car journeys. Two-tone design: front in red, back in black.

WAP0401010LKID

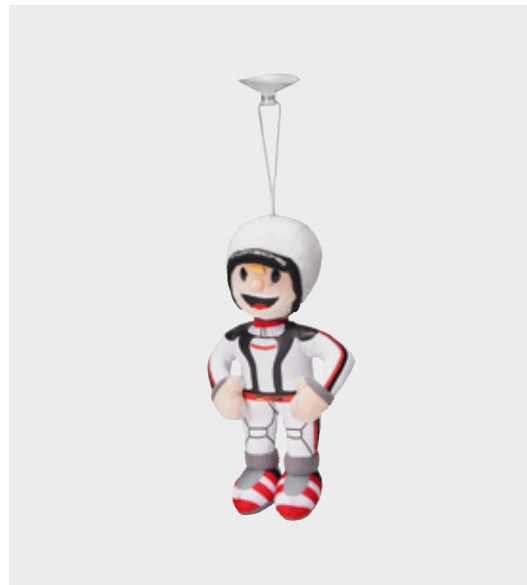

Tom Targa mini soft toy

Small cuddly-toy version of the popular Porsche mascot, Tom Targa. With suction cup. Dimensions: approx. 15cm.

WAP0400070MTOM



Tom Targa soft toy

Plush figure of the popular Porsche mascot Tom Targa. With dangling legs and removable helmet. Dimensions: approx. 30cm.

WAP0400080MTOM



Teddy bear

Ideal companion for the little ones: brown teddy bear in extra-soft plush. With red T-shirt bearing the Porsche logo.

WAP0401020LKID



Children's backpack

Spacious children's backpack in red with Porsche motif. Plenty of storage space thanks to main compartment with cord handle and buckle, covered pocket with zip and elastic side pockets. Optimum wearing comfort thanks to the padded back and straps as well as chest strap with height adjustment.

WAP0401030LKID



XL motorsport bear

Large teddy bear in Porsche Motorsport racing suit and black cap. Height: approx. 80cm.

WAP0400060MOMS



Plush 911 car

Made of high-quality plush. Length: approx. 35cm.

WAP0400020E



'From 0 to 911'

This illustrated children's book allows young and old to immerse themselves in the history of their favourite car: the Porsche 911. They can learn everything about the initial concepts, how a Porsche is built and get to know the various models.

WAP0409110JDEU



Lift-out puzzle

High-quality and robust wooden lift-out puzzle in the shape of a Porsche 911. Consisting of a total of 10 puzzle pieces. Size: approx. 28 × 12cm.

WAP0400040MSTP

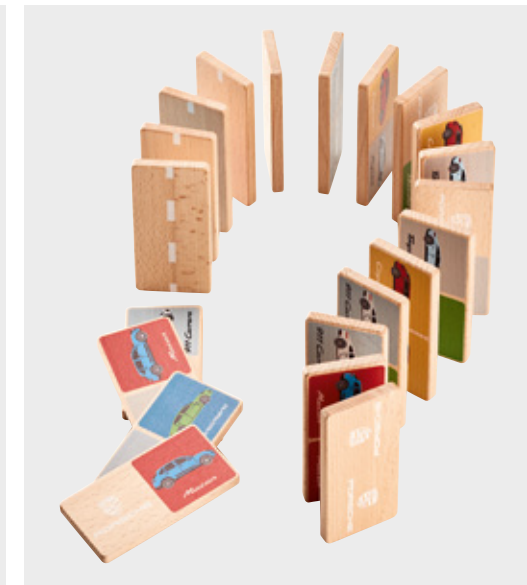

Domino set

High-quality domino set, consisting of 28 pieces. The dominoes show various Porsche models and the Porsche Crest. Approx. 12 × 6cm. Made of wood.

WAP0400030NDOM



Porsche Experience Centre set

An original Porsche Experience Centre comprehensive play set with more than 60 parts. Equipped with challenging on-road and off-road courses. The centre offers, among other things, a charging pedestal for hybrid vehicles, a ramp and a car wash. Five Porsche vehicles are included in the set so that you can start playing straight away.

WAP0401130MECS



PLAYMOBIL® play set Macan S – ‘Fire brigade’

PLAYMOBIL® play set, consisting of a character and a Macan S with removable roof, flashing light and sound as well as illuminated dashboard and lots of fire fighting accessories.

WAP0401100MPMF



PLAYMOBIL® play set 911 Carrera 4S – ‘Police’

PLAYMOBIL® play set, consisting of a character and a 911 Carrera 4S with removable roof and front, interior and rear lighting.

WAP0401110MPMP

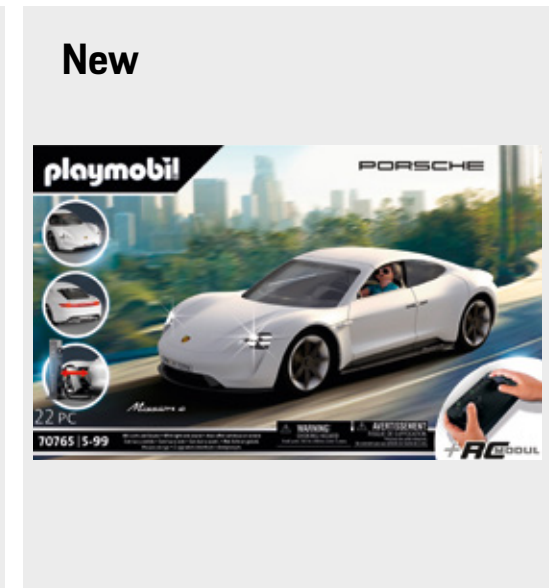

PLAYMOBIL® set – Mission E

Original play set from the concept study Mission E 2.0. With charging pedestal and RC steering. Four 1.5V AAA batteries required for light module. Three 1.5V AAA batteries required for remote control.

WAP0408010NPME

New



DE MADE IN GERMANY



PLAYMOBIL® play set – 'GT3 Cup'

PLAYMOBIL® play set with a 911 GT3 Cup, adorned with the silhouette of the Porsche Crest in the Porsche Motorsport colors.

WAP0408020NPMG

Baby Porsche with lighting

Control of headlights and taillight strip via an integrated touch switch that turns off automatically after 10 minutes. Non-slip security steering wheel with mechanical horn. With extra-wide whisper-quiet tyres. Ergonomically designed soft seat [removable]. For children aged between 18 months and 3 years. In Lava Orange. Made in Germany.

WAP0400050LBBP

DE MADE IN GERMANY



Baby Porsche Basis

Non-slip security steering wheel with mechanical horn. With extra-wide whisper-quiet tyres. Ergonomically designed soft seat [removable]. Headlights and taillights created from 3D synthetic elements. For children aged between 18 months and 3 years. In Miami Blue. Made in Germany.

WAP0400010M0BP



LEGO® Creator Set 911 Turbo and 911 Targa

Set consisting of 1,458 parts – for the Porsche 911 Turbo and the Porsche 911 Targa with roll-over bar and removable roof. With many moving parts such as steering wheel, gear shift, handbrake and seats. Made of 100% plastic.

WAP0400010NLCS





Wooden emergency vehicle set

Three wooden emergency vehicles including garage. Garage roof and doors are detachable. Fire engine in the shape of the Porsche Cayenne. Police car in the shape of the 911 Turbo. Ambulance in the shape of the Porsche Taycan. For children aged 3+ years. In natural/silver color/red/blue. Made in Europe.

WAP0400020LOEF



Race track starter set – Racing

High-end toy race track made of wood. Set consists of two cars, a start–finish marker, pit lane, podium, trophy and eight kerbs. Suitable for ages 3+. The starter set and all of the expansion sets are made of wood. Made in Europe.

WAP0400200J

Race track expansion set M – Racing

Expansion set includes eight kerbs, eight crash barriers, eighteen tyres and eight tubs. Suitable for children aged two and above. Made in Europe.

WAP0400400J

Race track expansion set S – Racing

Expansion set includes four kerbs, four crash barriers, nine tyres and four tubs. Suitable for children aged two and above. Made in Europe.

WAP0400300J

Race track expansion set L – Racing

Expansion set includes 12 kerbs, 12 crash barriers, 27 tyres, 12 tubs, an additional car and a bend. Suitable for children aged two and above. Made in Europe.

WAP0400500J



Wooden truck – Racing

Wooden race truck toy. Tractor with trailer and three race cars in Porsche Motorsport colors. The shape of the race cars is based on the 911. Length: approx. 33cm. Made of wood. In natural/red/black/white. Suitable for children aged two and above. Made in Europe.

WAP0400100H



Wooden car – Taycan

Wooden toy vehicle. Shape based on the Porsche Taycan. Length: approx. 12cm. 100% wood. For children aged two and above. Fits in the Porsche race truck. In natural/white/red/black. Made in Europe.

WAP0406000L



911 Carrera 4S pull-back – 1:43

In Lava Orange. Interior in black. Made of metal. Scale 1:43.

WAP0200270K



Model cars

The sporty elegance, the unmistakable silhouette, the athletic look of the wings – these are all features that every Porsche has and individually interprets for their own character. Features that have captivated design lovers and sports car enthusiasts alike for 70 years. In every scale. The model vehicles from Porsche Driver's Selection contain just as much attention to detail as every

Porsche, whether they're meant for the race track, the road or the desk. The miniatures are the same as their larger counterparts, right down to the wheel rims, and capture the charm of the sports car 1:1 – in the scales 1:43, 1:18 or 1:12.

911 Carrera 4S: fuel consumption in l/100km: urban 14.8–13.1 · extra urban 7.8–7.4 · combined 10.1–9.7 [NEDC]; combined 11.1–10.2 [WLTP]; CO₂ emissions in g/km combined: 231–222 [NEDC]; 253–231 [WLTP]



911 RSR steering wheel replica

On acrylic base featuring a Limited Edition plaque.
Made of resin. Scale 1:1.

WAP0260010MLKR



Model car showcase

High-quality model car showcase made of lightfast acrylic glass for ten vehicles in scale 1:43. Base has 'PORSCHE' logo.
Dimensions: tower 16cm [L] x 8.5cm [W] x 74cm [H], base plate 26cm [L] x 17cm [W] x 1.3cm [H].

WAP02077818

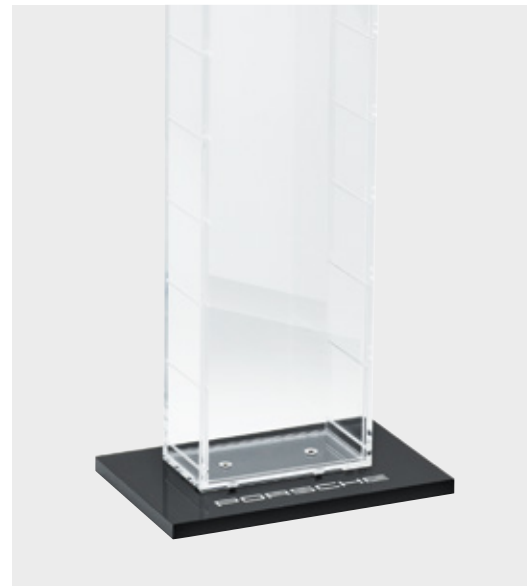



Model cars 1:43

**718 Cayman GTS 4.0**

In Carmine Red. Interior in black.
Made of metal. Scale 1:43.

WAP0204170L

**718 Boxster GTS 4.0**

In Python Green Metallic. Interior in black.
Made of metal. Scale 1:43.

WAP0202080L

**Cayman GT4 Calendar Edition**

In Racing Yellow. Interior in black.
Made of metal. Scale 1:43.

WAP0200870L002

**911 Carrera 4 Coupé**

In Carrara White Metallic. Interior in Agave Green.
Made of metal. Scale 1:43.

WAP0201760K

**911 Carrera 4S**

In Racing Yellow. Interior in black.
Made of metal. Scale 1:43.

WAP0201720K

**911 Carrera 4S pull-back**

In Lava Orange. Interior in black.
Made of metal. Scale 1:43.

WAP0200270K

**911 Carrera Cabriolet**

In Biscay Blue Metallic. Interior in black. Hood in black.
Made of metal. Scale 1:43.

WAP0201750K

**911 Carrera S Cabriolet**

In Night Blue Metallic. Interior in black/Mojave Beige.
Made of metal. Scale 1:43.

WAP0201710K



911 Carrera 4S Cabriolet

In Gentian Blue Metallic. Interior in Slate Grey/Crayon.
Made of metal. Scale 1:43.

WAP0201730K



911 GT3

In Shark Blue. Interior in black.
Made of metal. Scale 1:43.

WAP0201490M005



911 GT3

In Jet Black Metallic. Interior in black.
Made of metal. Scale 1:43.

WAP0201520M007



911 GT3

In Guards Red. Interior in black.
Made of metal. Scale 1:43.

WAP0201510M006



911 Targa 4S

In black. Interior in black/Island Green.
Made of metal. Scale 1:43.

WAP0201400L



911 Targa 4S Heritage Design Edition

In Cherry Metallic. Interior in Bordeaux Red/Atacama Beige.
Made of metal. Scale 1:43.

WAP0209110L



911 Targa 4S Heritage Design Edition

In Meissen Blue.
Made of metal. Scale 1:43.

WAP0209110NTRG



911 Turbo S Coupé 992

In GT Silver Metallic. Interior in black.
Made of metal. Scale 1:43.

WAP0201780K



911 Turbo S Cabrio 992

In GT Silver Metallic. Interior in black/red.
Made of metal. Scale 1:43.

WAP0201790K



911 Speedster

In Guards Red. Interior in black.
Made of resin. Scale 1:43.

WAP0209310K84A



911 Speedster with Heritage Design Package

In GT Silver Metallic. Interior in black/Cognac.
Made of resin. Scale 1:43.

WAP0201940K

Taycan



Taycan Turbo S

In Carrara White Metallic. Interior black/Slate Grey.
Made of metal. Scale 1:43.

WAP0207800L



Taycan 4S

In Frozen Blue Metallic. Interior in black/Slate Grey.
Made of metal. Scale 1:43.

WAP0207810L



Taycan Turbo S Calendar Edition

In Gentian Blue. Interior in black/Slate Gray.
Made of metal. Scale 1:43.

WAP0200880M003



Porsche Taycan 4S Cross Turismo

In Ice Grey Metallic. Interior in Basalt Black.
DieCast. Scale 1:43.

WAP0207840M005



Porsche Taycan Turbo S Cross Turismo

In Mamba Green Metallic.
Interior in Basalt Black/Meranti Brown.
Made of resin. Scale 1:43.

WAP0207830M003

New



Taycan Turbo S Cross Turismo

In Ice Grey Metallic. Interior in black/Crayon.
DieCast. Scale 1:43. Including gift packaging.

WAP0207880NTTC

New



Porsche Taycan Turbo S

In Frozen Berry Metallic/black.
DieCast. Scale 1:43. Including gift packaging.

WAP0207890NTTS

Cayenne



Cayenne S Coupé including sport package

In Lava Orange. Interior in black/Pepita.
Made of metal. Scale 1:43.

WAP0203180K



Cayenne Turbo Coupé

In Quarzite Grey Metallic. Interior in Graphite Blue/Crayon.
Made of metal. Scale 1:43.

WAP0203160K



Cayenne E-Hybrid Coupé

In Carrara White Metallic. Interior in black.
Made of metal. Scale 1:43.

WAP0203170K



Cayenne Turbo S E-Hybrid Coupé

In Carrara White Metallic. Interior in black.
Made of metal. Scale 1:43.

WAP0203210K



Cayenne

In Biscay Blue Metallic. Interior in black/Mojave Beige.
Made of metal. Scale 1:43.

WAP0203110J



Cayenne Turbo

In Moonlight Blue Metallic. Interior in black.
Made of metal. Scale 1:43.

WAP0203120J



Cayenne Turbo S E-Hybrid Coupé

In Carrara White Metallic.
Interior in Truffle Brown/Cohiba Brown.
Made of metal. Scale 1:43.

WAP0203140K

Motorsport



Formula E Calendar Edition

In white/black/red. Interior in black.
Made of metal. Scale 1:43.

WAP0200860L001



Formula E 'Neel Jani'

In white/black/red. Interior in black.
Made of metal. Scale 1:43.

WAP0209310L



Formula E 'Andre Lotterer'

In white/black/red. Interior in black.
Made of metal. Scale 1:43.

WAP0209320L



911 RSR 2019 #911

In white/grey/red. Interior in black.
Made of metal. Scale 1:43.

WAP020RSROL

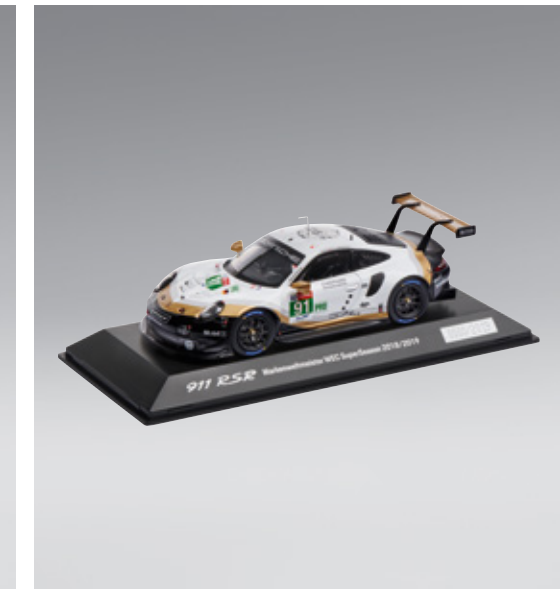

911 RSR 2019

In white/black/gold color. Interior in black.
Made of metal. Scale 1:43.

WAP0201480LRSR



911 GT3 R 2019

In black/white/green. Interior in black.
Made of metal. Scale 1:43.

WAP0209120K



Porsche 911 RSR #911 IMSA Farewell

In white/blue. Interior in black.
Made of resin. Scale 1:43.

WAP0200100N0FW



Porsche 911 RSR #912 IMSA Farewell

In red/blue. Interior in black.
Made of resin. Scale 1:43.

WAP0200110N0FW



911 RSR Le Mans 2020 #91

In red/white. Interior in black.
Made of resin. Scale 1:43.

WAP0209010MLEM



911 RSR Le Mans 2020 #92

In white/black. Interior in black.
Made of resin. Scale 1:43.

WAP0209020MLEM

Other vehicles



718 Cayman GT4 Clubsport

In black/yellow. Interior in black.
Made of metal. Scale 1:43.

WAP0204150K



911 RSR Turbo 2.1 Calendar Edition

Calendar Edition in silver color/multicolor. Interior in black.
Made of metal. Scale 1:43.

WAP0209110MRSR



935/78 Moby Dick Calendar Edition

In white/multicolor. Interior in black.
Made of metal. Scale 1:43.

WAP0209350MMDE



Porsche 961 Calendar Edition

In white. Interior in black.
Made of metal. Scale 1:43.

WAP0209610MKED

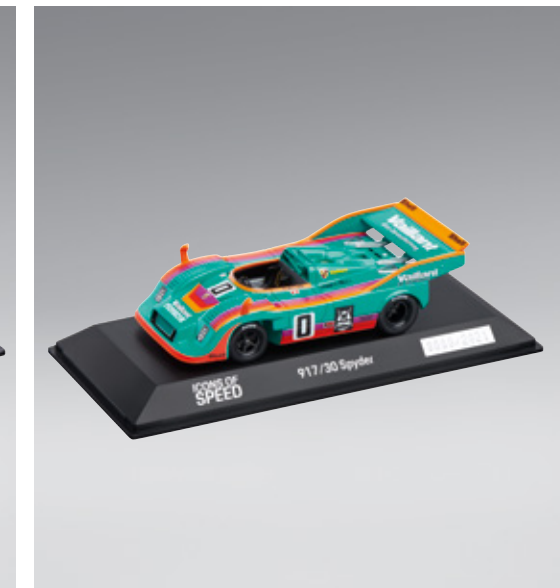

917/30 Calendar Edition

In green/multicolor. Interior in black.
Made of resin. Scale 1:43.

WAP0209170MKED



911 GT2 RS Clubsport

In white. Interior in black.
Made of metal. Scale 1:43.

WAP0201530L



917 Salzburg

In red/white. Interior in black.
Made of resin. Scale 1:43.

WAP0209400M917



917 Living Legend

In red/white. Interior in black.
Made of metal. Scale 1:43.

WAP0209340L



935 Salzburg

In red/white. Interior in black.
Made of resin. Scale 1:43.

WAP0209410M935



Porsche 959 Rallye

In blue/white/red. Interior in black.
Made of resin. Scale 1:43.

WAP0209590NRLL



Porsche 935/19 JPS

In black/gold color. Interior in black.
DieCast. Scale 1:43.

WAP0209510MJPS



Porsche 935/19 Carrera

In blue/red. Interior in black.
DieCast. Scale 1:43.

WAP0209520MOCR



Porsche 935/19 no. 71

In green/gold color. Interior in black.
DieCast. Scale 1:43.

WAP0209530MJMS



Porsche 935/19 Champion

In white. Interior in black.
DieCast. Scale 1:43.

WAP0209540MCMP



Model cars 1:18

718 Boxster S:

fuel consumption in l/100km: urban 12.9–12.4 · extra urban 7.6–7.0 · combined 9.6–8.8 [NEDC];
combined 10.4–9.6 [WLTP]; CO₂ emissions in g/km combined: 218–200 [NEDC] 235–218 [WLTP]

**911 4S Cabriolet**

In Lizard Green. Interior in black.
Made of metal. Scale 1:18.

WAP0211730LM6B

**911 GT3**

In Shark Blue. Interior in black.
Made of resin. Scale 1:18.

WAP0211490M003

**911 GT3**

In GT Silver Metallic. Interior in black.
Made of resin. Scale 1:18.

WAP0211510M004

**911 Targa 4S Heritage Design Edition**

In Cherry Metallic. Interior in Bordeaux Red/Atacama Beige.
Made of resin. Scale 1:18.

WAP0219110MTRG

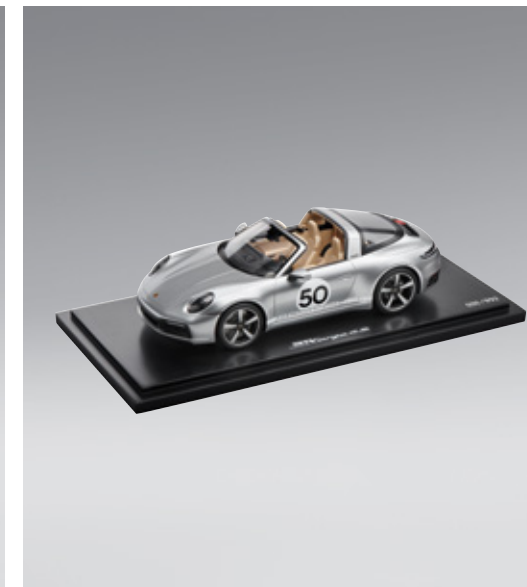
**911 Targa 4S Heritage Design Edition**

In Silver Metallic. Interior in black/Atacama Beige.
Made of resin. Scale 1:18.

WAP0219120MTRG



911 Turbo S 992

In black. Interior in black.
Made of metal. Scale 1:18.

WAP02117B0L002



911 Turbo S 992

In Oakgreen Metallic. Interior in black/Island green.
Made of resin. Scale 1:18.

WAP02117C0L002



911 Speedster

In black. Interior in black.
Made of resin. Scale 1:18.

WAP0219320K041

Taycan



Taycan 4S

In Frozen Blue Metallic.
Interior in black/Slate Grey.
Made of metal. Scale 1:18.

WAP0217810L



Taycan Turbo S

In Carrara White Metallic.
Interior in black/Slate Grey.
Made of resin. Scale 1:18.

WAP0217800L



Porsche Taycan 4S Cross Turismo

In Ice Grey Metallic.
Interior in Basalt Black.
Made of resin. Scale 1:18.

WAP0217840M004



Porsche Taycan Turbo S Cross Turismo

In Gentian Blue Metallic.
Interior in Basalt Black/Meranti Brown.
Made of metal. Scale 1:18.

WAP0217830M002



Porsche Taycan Turbo S Cross Turismo

In Mamba Green Metallic.
Interior in Basalt Black/Meranti Brown.
Made of resin. Scale 1:18.

WAP0217830M001

Cayenne



Cayenne Turbo Coupé

In black. Interior in black/Mojave.
Doors and boot/bonnet can be opened.
Made of metal. Scale 1:18.

WAP0213200K



Cayenne Turbo Coupé

In Mahogany Metallic. Interior in black.
Doors and boot/bonnet can be opened.
Made of metal. Scale 1:18.

WAP0213190K



Cayenne Coupé S

In Lava Orange. Interior in black/Pepita.
Made of metal. Scale 1:18.

WAP0213180K



Cayenne Coupé S

In Dolomite Silver. Interior in black/Pepita.
Made of metal. Scale 1:18.

WAP0213220K

Motorsport



911 RSR 2019 #911

In white/grey/red. Interior in black.
Made of resin. Scale 1:18.

WAP021RSROL



911 RSR 2019

In white/black/gold color. Interior in black.
Made of resin. Scale 1:18.

WAP0211480LRSR



Porsche 911 RSR #911 IMSA Farewell

In white/blue. Interior in black.
Made of resin. Scale 1:18.

WAP0210120NOFW

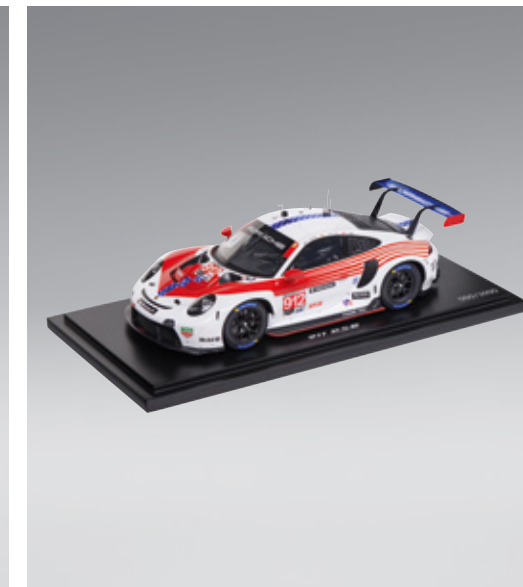

Porsche 911 RSR #912 IMSA Farewell

In red/blue. Interior in black.
Made of resin. Scale 1:18.

WAP0210130NOFW



911 RSR Le Mans 2020 #91

In red/white. Interior in black.
Made of resin. Scale 1 : 18.

WAP0219030MLEM



911 RSR Le Mans 2020 #92

In white/black. Interior in black.
Made of resin. Scale 1 : 18.

WAP0219040MLEM

Other vehicles



911 GT2 RS Clubsport
In white. Interior in black.
Made of resin. Scale 1:18.

WAP0211530L



718 Cayman GT4 Clubsport
In black/yellow. Interior in black.
Made of resin. Scale 1:18.

WAP0214150K



935/19 DC
In white/multicolor. Interior in black.
Made of metal. Scale 1:18.

WAP0219020K



917 Salzburg
In red/white. Interior in black.
Made of resin. Scale 1:18.

WAP0219400M917

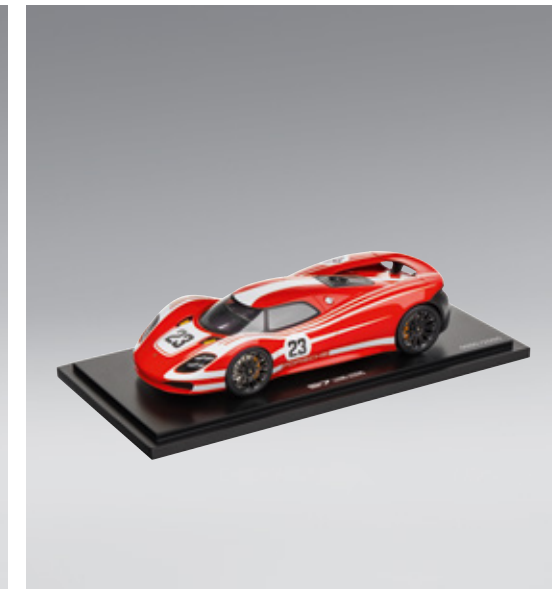

917 Living Legend
In red/white. Interior in black.
Made of resin. Scale 1:18.

WAP0219340L



935 Salzburg

In red/white. Interior in black.
Made of resin. Scale 1:18.

WAP0219410M935



Porsche 959 Rallye

In blue/white/red. Interior in black.
Made of resin. Scale 1:18.

WAP0219590NRL



Model cars 1:12

911 Speedster: fuel consumption [in l/100km] urban 20.6 · extra urban 9.9 · combined 13.8;
CO₂ emissions [in g/km] combined 317



911 Speedster – Limited Edition

Limited to 300 pieces. In Guards Red.
Interior in black.
Made of resin. Scale 1:12.

WAP0239300K84A



911 GT2 RS Clubsport

In black/multicolor. Interior in black.
Made of resin. Scale 1:12.

WAP0231530L



911 RSR 2019 #911

In white/grey/red. Interior in black.
Made of resin. Scale 1:12.

WAP023RSR0L

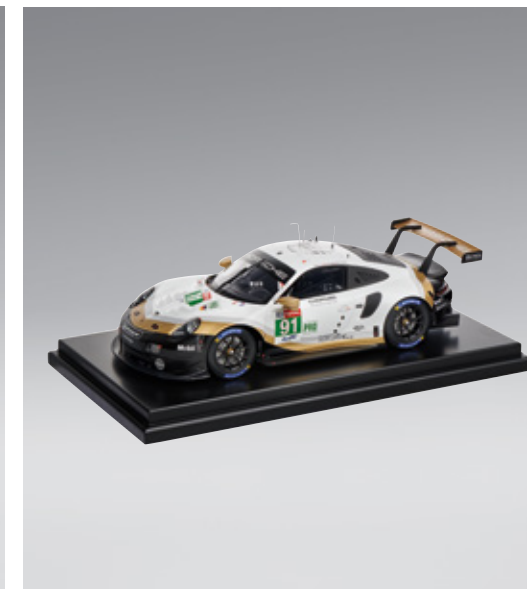

911 RSR 2019

In white/black/gold color. Interior in black.
Made of resin. Scale 1:12.

WAP0231480LRSR

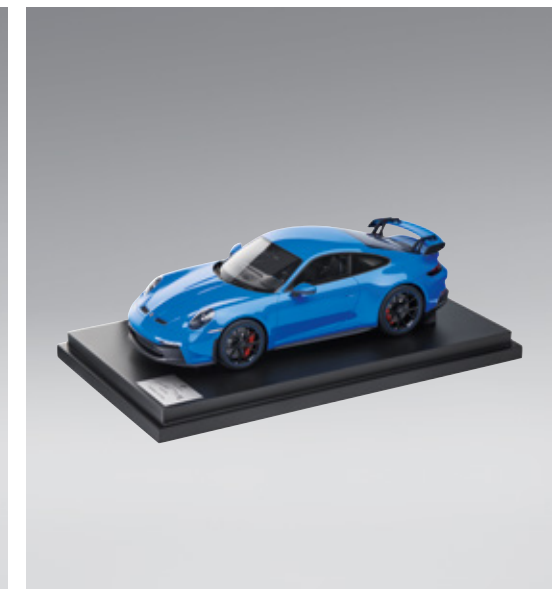

Porsche 911 GT3

In Shark Blue. Interior in black.
Made of resin. Scale 1:12.

WAP0231490M001



Porsche 911 GT3

In GT Silver Metallic. Interior in black.

Made of resin. Scale 1 : 12.

WAP0231510M002

Standard clothing sizes

The clothing sizes are part of the WAP number. Example: men's polo shirt. WAP75000S-3XLOB

The men's polo shirt is available in all sizes from S to 3XL [S, M, L, XL, XXL, 3XL].

Size guidance: the male model is approx. 1.85m tall and wears size M.

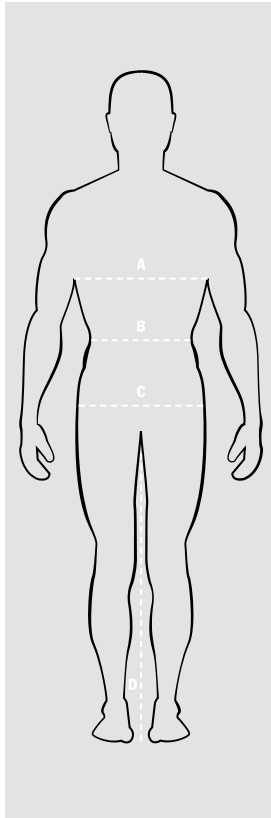

Men/Unisex	XS	S	M	L	XL	XXL	3XL
Germany	40-42	44-46	48-50	52-54	56-58	60-62	64-66
France	40-42	44-46	48-50	52-54	56-58	60-62	64-66
Italy	40-42	44-46	48-50	52-54	56-58	60-62	64-66
Russia	40-42	44-46	48-50	52-54	56-58	60-62	64-66
United Kingdom	32-34	36-38	40-42	44-46	48-50	52-54	56-58
USA	34	36	38-40	42-44	46-48	50	52
China – upper clothing [height/chest]	175/80A- 175/84A	175/88A- 180/92A	180/96A- 180/100A	180/104B- 180/108B	185/112B- 185/116B	185/120B- 185/124B	185/128B- 190/132B
China – lower clothing [height/waist]	175/66A- 175/70A	175/74A- 180/78A	180/84A- 180/88A	180/94B- 180/98B	185/102B- 185/108B	185/112B- 185/116B	185/120B- 190/124B
A Chest size	84.0cm 33"	88.0-92.0cm 34 1/2-36 1/4"	96.0-100.0cm 37 3/4-39 1/2"	104.0-108.0cm 41-42 1/2"	112.0-116.0cm 44-45 3/4"	120.0-124.0cm 47 1/4-48 3/4"	128.0-132.0cm 50 1/2-52"
B Waist size	70.0cm 27 1/2"	74.0-78.0cm 29-30 3/4"	83.0-88.0cm 32 3/4-34 1/2"	93.0-98.0cm 36 1/2-38 1/2"	102.0-107.0cm 40 1/4-42"	111.0-116.0cm 43 3/4-45 3/4"	120.0-124.0cm 47 1/4-48 3/4"
C Hip size	90.0cm 35 1/2"	93.0-96.0cm 36 1/2-37 3/4"	99.0-102.0cm 39-40 1/4"	105.0-108.0cm 41 1/4-42 1/2"	111.0-114.0cm 43 3/4-45"	117.0-120.0cm 46-47 1/4"	123.0-126.0cm 48 1/2-49 1/2"
D Inside leg length	81.0cm 32"	81.5-82.0cm 32-32 1/4"	82.5-83.0cm 32 1/2-32 3/4"	83.5-84.0cm 33"	84.5-85.0cm 33 1/4-33 1/2"	85.5-86.0cm 33 3/4-34"	86.5-87.0cm 34-34 1/4"

The clothing sizes are part of the WAP number. Example: women's polo shirt. WAP7450XS-XXLOB

The women's polo shirt is available in all sizes from XS to XXL [XS, S, M, L, XL, XXL].

Size guidance: the female model is approx. 1.75m tall and wears size S.

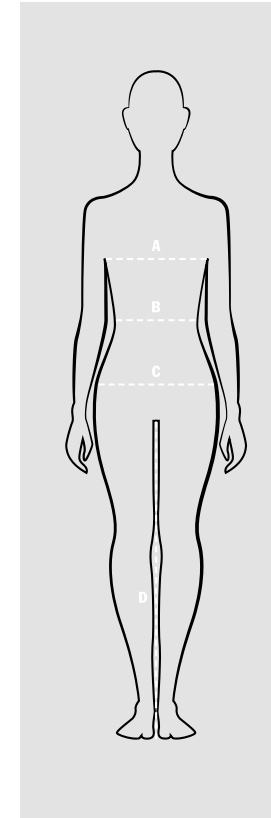

Women	XS	S	M	L	XL	XXL
Germany	32-34	36-38	40-42	44-46	48-50	52-54
France	34-36	38-40	42-44	46-48	50-52	54-56
Italy	36-38	40-42	44-46	48-50	52-54	56-58
Russia	38-40	42-44	46-48	50-52	54-56	58-60
United Kingdom	6-8	10-12	14-16	18-20	22-24	26-28
USA	00-0	2-4	6-8	10-12	14-16	18-20
China – upper clothing [height/chest]	165/76A- 165/80A	165/84A- 170/88A	170/92A- 170/96A	170/100A- 170/104B	170/108B- 170/116B	175/120B- 175/128B
China – lower clothing [height/waist]	165/62A- 165/66A	165/70A- 170/72A	170/76A- 170/80A	170/84A-1 70/92B	170/96B- 170/104B	175/108B- 175/116B
A Chest size	76.0-80.0cm 30-31 1/2"	84.0-88.0cm 33-34 1/2"	92.0-96.0cm 36 1/4-37 3/4"	100.0-104.0cm 39 1/2-41"	110.0-116.0cm 43 1/4-45 3/4"	122.0-128.0cm 48-50 1/2"
B Waist size	63.0-66.0cm 24 3/4-26"	69.0-72.0cm 27 1/4-28 1/4"	76.0-80.0cm 30-31 1/2"	85.0-90.0cm 33 1/2-35 1/2"	96.5-103.0cm 38-40 1/2"	109.5-116.0cm 43-45 3/4"
C Hip size	85.0-89.0cm 33 1/2-35"	93.0-97.0cm 36 1/2-38 1/4"	100.0-103.0cm 39 1/2-40 1/2"	106.0-109.0cm 41 3/4-43"	114.0-119.0cm 45-47"	124.0-130.0cm 48 3/4-51 1/4"
D Inside leg length	78.2cm 30 3/4"	78.1-78.2cm 30 3/4"	77.9-78cm 30 3/4"	77.7-77.8cm 30 1/2"	77.3-77.5cm 30 1/2"	76.9-77.1cm 30 1/4-30 1/2"

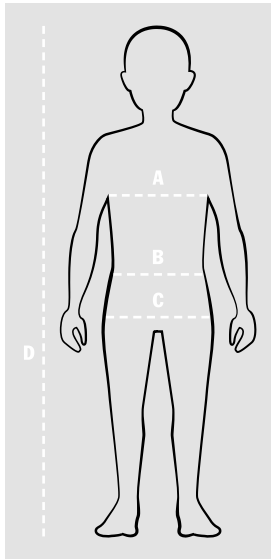

The available clothing sizes are included in the WAP number. Example: children's polo shirt. WAP 675 098-158 OH
 The children's polo shirt is available in all sizes from 98 to 158. [98/104, 110/116, 122/128, 134/140, 146/152, 158/164].

Children

Sizes	98/104	110/116	122/128	134/140	146/152	158/164
Approximate age	3-4	5-6	6-7	8-10	10-12	14-16
A Chest size	56.0-58.0cm 22-22 3/4"	59.0-61.0cm 23 1/4-24"	63.0-65.0cm 24 3/4-25 1/2"	67.0-70.0cm 26 1/2-27 1/2"	73.0-77.0cm 28 3/4-30 1/4"	81.0-85.0cm 32-33 1/2"
B Waist size	51.0-52.0cm 20-20 1/2"	53.0-54.0cm 21-21 1/4"	56.0-58.0cm 22-22 3/4"	60.0-62.0cm 23 1/2-24 1/2"	65.0-68.0cm 25 1/2-26 3/4"	71.0-74.0cm 28-29"
C Hip size	58.0-60.0cm 22 3/4-23 1/2"	62.0-65.0cm 24 1/2-25 1/2"	67.0-70.0cm 26 1/2-27 1/2"	73.0-76.0cm 28 3/4-30"	80.0-84.0cm 31 1/2-33"	88.0-92.0cm 34 1/2-36 1/4"
D Height	98-104cm 38 1/2-41"	110-116cm 43 1/4-45 3/4"	122-128cm 48-50 1/4"	134-140cm 52 3/4-55"	146-152cm 57 1/2-59 3/4"	158-164cm 62 1/4-64 1/2"

Babies

Sizes	44-50	50-56	56-62	62-68	68-74	74-80	80-86	86-92
Approximate age	0-1 months	1-2 months	2-3 months	3-6 months	6-9 months	9-12 months	12-18 months	18-24 months
Height	44-50cm 17-20"	50-56cm 20-22"	56-62cm 22-24"	62-68cm 24-27"	68-74cm 27-29"	74-80cm 29-31"	80-86cm 31-34"	86-92cm 34-36"
Weight	2-4kg 4-8lb	3-5kg 7-11lb	4-7kg 9-15lb	6-9kg 13-20lb	6-12kg 13-26lb	7-13kg 15-29lb	8-15kg 18-33lb	10-17kg 22-37lb

Professional motorsport

Women

Sizes	Height	Weight
A	1.55m	45kg
B	1.60m	50kg
C	1.65m	55kg
D	1.70m	60kg
E	1.75m	65kg

Men

Sizes	Height	Weight
0	1.65m	65kg
1	1.70m	70kg
2	1.75m	75kg
3	1.80m	80kg
4	1.85m	85kg
5	1.90m	90kg
6	1.95m	95kg
7	1.95m	100kg
8	1.95m	120kg
9	1.90m	135kg
10	1.90m	150kg

Bikes

Frame sizes	Height*
S	160-170cm
M	171-184cm
L	184-195cm

*Maximum system weight: 120kg

Luggage combinations, 718 Cayman models*

PTS Multiwheel® Ultralight Edition luggage, possible combinations for the rear:



2 × M

PTS Multiwheel® Ultralight Edition luggage, possible combinations for the front:



2 × M

or



1 × XL



Luggage combinations, 718 Boxster models*

PTS Multiwheel® Ultralight Edition luggage, possible combinations for the rear:



1 × M

PTS Multiwheel® Ultralight Edition luggage, possible combinations for the front:



2 × M

or



1 × XL



*Sample loading options, other combinations are possible.

The loading options shown refer to standard vehicles with standard specification in the German market. These may vary in the case of optional equipment or right-hand drive vehicles.

718 Boxster and 718 Cayman models: fuel consumption in l/100km: urban 15.0–10.6 · extra urban 8.5–6.5 · combined 10.9–8.1 [NEDC]; combined 11.1–8.9 [WLTP];

CO₂ emissions in g/km combined: 249–185 [NEDC]; 251–201 [WLTP]

Luggage combinations, 911 Carrera Coupé models*

PTS Multiwheel® Ultralight Edition luggage, possible combinations for the front:



2 × M

or



1 × XL



Luggage combinations, 911 Carrera Cabriolet models*

PTS Multiwheel® Ultralight Edition luggage, possible combinations for the front:



2 × M

or



1 × XL



*Sample loading options, other combinations are possible.

The loading options shown refer to standard vehicles with standard specification in the German market. These may vary in the case of optional equipment or right-hand drive vehicles.

911 Carrera models: fuel consumption in l/100km: urban 15.4–12.6 · extra urban 8.0–7.3 · combined 10.6–9.4 [NEDC]; combined 11.4–10.1 [WLTP];

CO₂ emissions in g/km combined: 242–215 [NEDC]; 259–229 [WLTP]

Luggage combinations, 911 Turbo models*

PTS Multiwheel® Ultralight Edition luggage, possible combinations for the front:



2 × M

or



1 × XL



Luggage combinations, Panamera models with pulled-out retractable rear luggage compartment cover*

PTS Multiwheel® Ultralight Edition luggage, rear luggage compartment:



4 × M

or



2 × XL

or



2 × XXL

or



2 × M
1 × XL

or



2 × M
1 × XXL

or



1 × XL
1 × XXL



Luggage combinations, Panamera models with hat shelf*

PTS Multiwheel® Ultralight Edition luggage, rear luggage compartment:



4 × M

or



2 × XL

or



2 × XXL

or



2 × M
1 × XL

or



2 × M
1 × XXL



*Sample loading options, other combinations are possible.

The loading options shown refer to standard vehicles with standard specification in the German market. These may vary in the case of optional equipment or right-hand drive vehicles.

911 Turbo models: fuel consumption in l/100km: urban 15.9–15.2 · extra urban 8.9–8.6 · combined 11.3–11.1 [NEDC]; combined 12.5–12.0 [WLTP];

CO₂ emissions in g/km combined: 257–254 [NEDC]; 284–271 [WLTP]

*Sample loading options, other combinations are possible.

The loading options shown refer to standard vehicles with standard specification in the German market. These may vary in the case of optional equipment or right-hand drive vehicles.

Panamera models: fuel consumption in l/100km: urban 15.4–11.0 · extra urban 8.7–7.0 · combined 11.0–8.6 [NEDC]; combined 13.2–10.2 [WLTP];

CO₂ emissions in g/km combined: 251–197 [NEDC]; 299–232 [WLTP]

Luggage combinations, Panamera models without rear luggage compartment cover and hat shelf*

PTS Multiwheel® Ultralight Edition luggage, rear luggage compartment:



*Sample loading options, other combinations are possible.

The loading options shown refer to standard vehicles with standard specification in the German market. These may vary in the case of optional equipment or right-hand drive vehicles.

Luggage combinations, Panamera 4 E-Hybrid models with pulled-out retractable rear luggage compartment cover and pocket for charging cable*

PTS Multiwheel® Ultralight Edition luggage, rear luggage compartment:



Volume variants of the Panamera 4 E-Hybrid models without luggage compartment roller and with charging cable pocket*

PTS Multiwheel® Ultralight Edition luggage, rear luggage compartment:



*Sample loading options, other combinations are possible.

The loading options shown refer to standard vehicles with standard specification in the German market. These may vary in the case of optional equipment or right-hand drive vehicles.

Panamera 4 E-Hybrid models: fuel consumption combined in l/100km: 2.3–2.1 [NEDC]; 2.7–2.0 [WLTP, weighted]; CO₂ emissions combined in g/km: 51–47 [NEDC]; 60–45 [WLTP, weighted]; electricity consumption combined in kWh/100km: 18.2–17.0 [NEDC]; 24.9–22.6 [WLTP, weighted]; all-electric range in accordance with WLTP in km: 47–56 [EAER]

Luggage combinations, Panamera Sport Turismo models with pulled-out retractable rear luggage compartment cover*

PTS Multiwheel® Ultralight Edition luggage, rear luggage compartment:



Luggage combinations, Panamera Sport Turismo models without rear luggage compartment cover*

PTS Multiwheel® Ultralight Edition, luggage compartment rear:



*Sample loading options, other combinations are possible.

The loading options shown refer to standard vehicles with standard specification in the German market. These may vary in the case of optional equipment or right-hand drive vehicles.

Panamera Sport Turismo models: fuel consumption in l/100km: urban 15.5–11.2 · extra urban 8.8–7.5 · combined 11.1–8.9 [NEDC]; combined 13.3–10.6 [WLTP]; CO₂ emissions in g/km combined: 253–202 [NEDC]; 302–241 [WLTP]

Luggage combinations, Macan models*

PTS Multiwheel® Ultralight Edition luggage, possible combinations for the rear:



Luggage combinations, Cayenne models*

PTS Multiwheel® Ultralight Edition luggage, possible combinations for the rear:



*Sample loading options, other combinations are possible.

The loading options shown refer to standard vehicles with standard specification in the German market. These may vary in the case of optional equipment or right-hand drive vehicles.

Macan models: fuel consumption in l/100km: urban 12.1–9.5 · extra urban 8.3–7.4 · combined 9.6–8.2 [NEDC]; combined 12.0–10.2 [WLTP]; CO₂ emissions in g/km combined: 218–186 [NEDC]; 271–232 [WLTP]

Luggage combinations, Cayenne models with pulled-out retractable rear luggage compartment cover*

PTS Multiwheel® Ultralight Edition luggage, possible combinations for the rear:



Luggage combinations, Cayenne models without rear luggage compartment cover*

PTS Multiwheel® Ultralight Edition luggage, possible combinations for the rear:



*Sample loading options, other combinations are possible.

The loading options shown refer to standard vehicles with standard specification in the German market. These may vary in the case of optional equipment or right-hand drive vehicles.

Cayenne models: fuel consumption in l/100km: urban 16.6–11.2 · extra urban 9.3–7.8 · combined 11.9–9.2 [NEDC]; combined 14.1–11.5 [WLTP];

CO₂ emissions in g/km combined: 271–210 [NEFZ]; 319–259 [WLTP]

Cayenne E-Hybrid models: fuel consumption combined in l/100km: 3.3–2.4 [NEDC]; 4.1–3.1 [WLTP, weighted]; CO₂ emissions combined in g/km: 76–56 [NEDC]; 92–71 [WLTP, weighted];

electricity consumption combined in kWh/100km: 23.5–25.1 [NEDC]; 23.3–21.6 [WLTP, weighted]; all-electric range in accordance with WLTP in km: 39–44 [EAER]

Volume options, Taycan models*

PTS Multiwheel® Ultralight Edition, possible combinations for the rear:



*Sample loading options, other combinations are possible.

The loading options shown refer to standard vehicles with standard specification in the German market. These may vary in the case of optional equipment or right-hand drive vehicles.

Taycan models: electricity consumption combined in kWh/100km: 29.4–26.2 [NEDC]; 26.6–20.4 [WLTP]; CO₂ emissions combined in g/km: 0 [NEDC]; 0 [WLTP];

all-electric range in km: 335–484 [WLTP]; 382–541 [WLTP, urban];

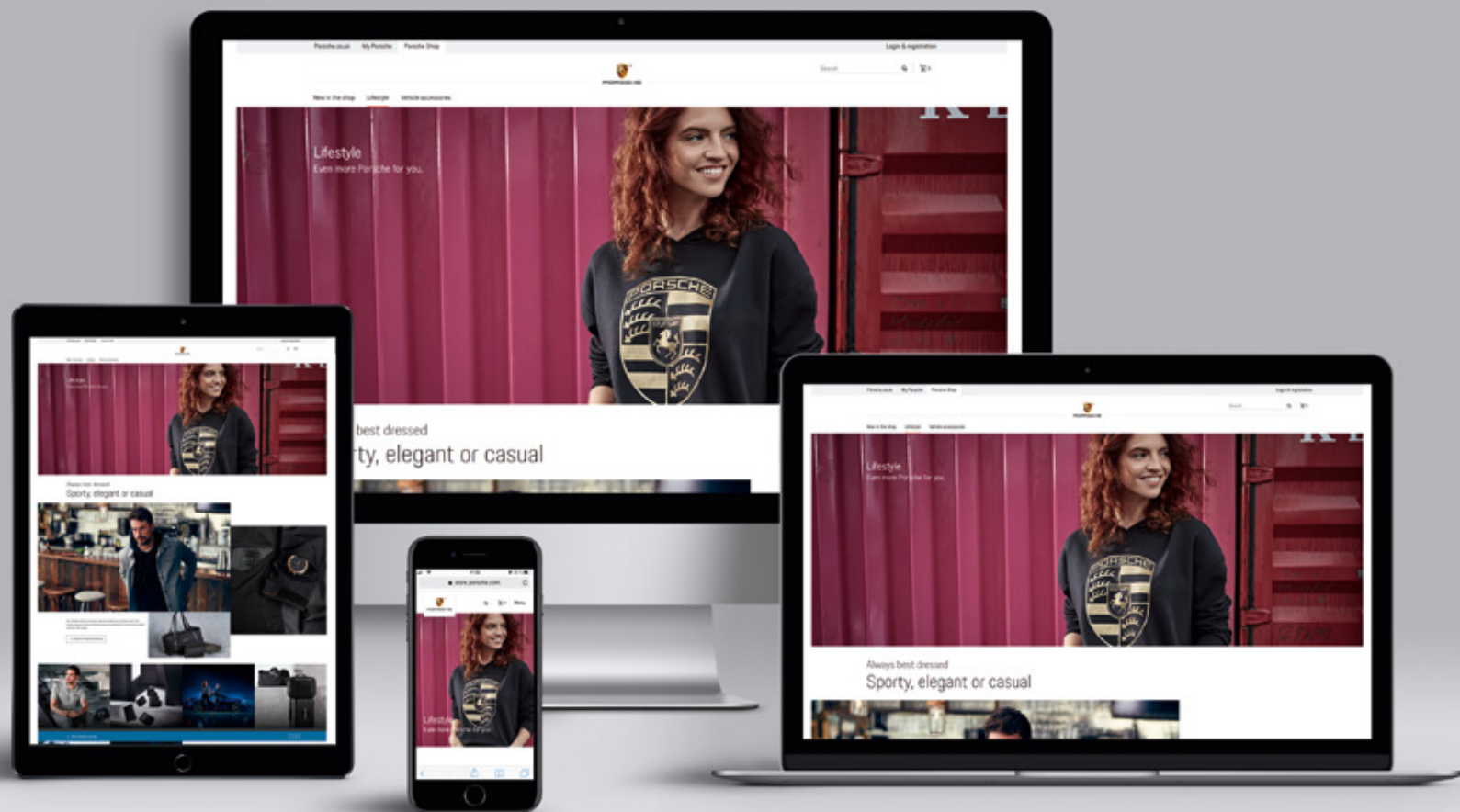

The Porsche Driver's Selection products are available in Porsche Centres and via the online shop at shop.porsche.com

The **SELECT** magazine from Porsche Driver's Selection contains the latest collections and other exciting information from Porsche World. It is printed and issued twice a year and available from your Porsche Centre or as an online version 24/7.

Visit us at shop.porsche.com

For more information, please contact your nearest Porsche Centre by telephone on +49 [0] 711 911-0 or visit www.porsche.com



Porsche Lizenz- und Handelsgesellschaft mbH & Co. KG | Grönerstraße 5 | 71636 Ludwigsburg | Germany
www.porsche.com | Edition: 11/2021

Products are exclusively available from Porsche Centres and at shop.porsche.com Service hotline: +49 [0]800 8000-911

Colors may differ from those illustrated. Errors and omissions excepted. Porsche, Porsche Design, the Porsche Crest, 911, Carrera, Taycan, Targa, Boxster, Cayenne, Cayman, Macan, Panamera, 918 Spyder, Tequipment and other marks are registered trademarks of Dr. Ing. h.c. F. Porsche AG. Due to country-specific regulations, some products may not be available in your country. If you are interested in a product, please contact your nearest Porsche Centre.

The MARTINI RACING® brand name, the MARTINI RACING® stripe and the MARTINI 'Ball & Bar' logo have been used with the consent of the rights holder.